

SIEMENS

FLUOROSPOT[®] Compact VF30

Multi-platform imaging system used by:

Luminos dRF VC10

Luminos Agile VC10

Luminos Fusion VC10

Luminos Select VC10

Ysio VC10

Multix Select DR VA10

Multix DR upgrade VA20

UROSKOP Omnia VC10

XP

DICOM Conformance Statement

V6.4 July 15, 2011

Global Business Unit
Siemens AG, Medical Solutions
X-Ray Products
Henkestrasse 127
D-91052 Erlangen

Global Siemens Headquarters / Legal Manufacturer
Siemens AG
Wittelsbacher Platz 2
D-80333 Muenchen, Germany

Printed in Germany

Table of Contents

Network Conformance Statement	7
1 Introduction	7
1.1 Overview	7
1.2 Scope and Field.....	7
1.3 Audience	8
1.4 Remarks	8
1.5 Definitions, Terms and Abbreviations.....	9
1.6 References	9
1.7 Structure	9
2 Implementation Model Verification	10
2.1 Application Data Flow Diagram	10
2.2 Functional Definitions of Applications.....	10
2.3 Sequencing of Real-World Activities.....	10
3 Application Entity Specification Verification	11
3.1 Verification AE Specification	11
3.1.1 Association Establishment Policies	11
3.1.1.1 General.....	11
3.1.1.2 Number of Associations.....	11
3.1.1.3 Asynchronous Nature.....	11
3.1.1.4 Implementation Identifying Information	11
3.1.2 Association Initiation Policy	11
3.1.2.1 Associated Real-World Activity.....	11
3.1.3 Association Acceptance Policy	12
4 Implementation Model Storage	13
4.1 Application Data Flow Diagram	13
4.2 Functional Definitions of Application Entities.....	13
4.3 Sequencing of Real-World Activities.....	14
5 Application Entity Specification Storage	15
5.1 Storage AES Specification	15
5.1.1 Association Establishment Policies	15
5.1.1.1 General.....	15
5.1.1.2 Number of Associations.....	16
5.1.1.3 Asynchronous Nature.....	16
5.1.1.4 Implementation Identifying Information	16
5.1.2 Association Initiation Policy	16
5.1.2.1 Associated Real-World Activity – Storage SCU	16
5.1.3 Association Acceptance Policy	19
5.1.3.1 Associated Real-World Activity – Storage SCP	19

6	<i>Implementation Model Storage Commitment</i>	21
6.1	Application Data Flow Diagram	21
6.2	Functional Definitions of Application Entities.....	21
6.3	Sequencing of Real-World Activities.....	22
7	<i>AE Specification Storage Commitment</i>	23
7.1	Storage Commitment AE Specification.....	23
7.1.1	Association Establishment Policies	23
7.1.1.1	General.....	23
7.1.1.2	Number of Associations.....	23
7.1.1.3	Asynchronous Nature.....	23
7.1.1.4	Implementation Identifying Information	23
7.1.2	Association Initiation Policy	23
7.1.2.1	Real World Activity – Storage Commitment SCU.....	24
7.1.3	Association Acceptance Policy.....	24
7.1.3.1	Real World Activity – Storage Commitment SCU.....	25
8	<i>Implementation Model Query / Retrieve</i>	26
8.1	Application Data Flow Diagram	26
8.2	Functional Definitions of Application Entities.....	26
8.3	Sequencing of Real-World Activities.....	26
9	<i>AE Specification Query/Retrieve</i>	27
9.1	Query/Retrieve Service AEs Specification.....	27
9.1.1	Association Establishment Policies	27
9.1.1.1	General.....	27
9.1.1.2	Number of Associations.....	27
9.1.1.3	Asynchronous Nature.....	27
9.1.1.4	Implementation Identifying Information	27
9.1.2	Association Initiation Policy	28
9.1.2.1	Real World Activity – Find SCU.....	28
9.1.2.2	Real-World Activity – Move SCU.....	30
9.1.3	Association Acceptance Policy.....	32
10	<i>Implementation Model Modality Worklist</i>	33
10.1	Application Data Flow Diagram	33
10.2	Functional Definitions of Application Entities	33
10.3	Sequencing of Real-World Activities	33
11	<i>AE Specification Modality Worklist</i>	34
11.1	Modality Worklist Service AEs Specification	34
11.1.1	Association Establishment Policies	34
11.1.1.1	General.....	34
11.1.1.2	Number of Associations.....	34
11.1.1.3	Asynchronous Nature.....	34
11.1.1.4	Implementation Identifying Information	34
11.1.2	Association Initiation Policy	34
11.1.2.1	Real-World Activity	35
11.1.3	Association Acceptance Policy.....	36
12	<i>Implementation Model Modality Performed Procedure Step</i>	37
12.1	Application Data Flow Diagram	37

12.2	Functional Definitions of Application Entities	37
12.3	Sequencing of Real-World Activities	37
13	<i>AE Specification Modality Performed Procedure Step.....</i>	38
13.1	Modality Performed Procedure Step Service AEs Specification.....	38
13.1.1	Association Establishment Policies	38
13.1.1.1	General.....	38
13.1.1.2	Number of Associations.....	38
13.1.1.3	Asynchronous Nature.....	38
13.1.1.4	Implementation Identifying Information	38
13.1.2	Association Initiation Policy	38
13.1.2.1	Real-World Activity	39
13.1.3	Association Acceptance Policy.....	40
14	<i>Implementation Model Print.....</i>	41
14.1	Application Data Flow Diagram	41
14.2	Functional Definition of Application Entities	41
14.3	Sequencing of Real-World Activities	41
15	<i>Application Entity Specification Print.....</i>	42
15.1	Print Management AE Specification	42
15.1.1	Association Establishment Policies	42
15.1.1.1	General.....	42
15.1.1.2	Number of Associations.....	42
15.1.1.3	Asynchronous Nature.....	42
15.1.1.4	Implementation Identifying Information	42
15.1.2	Association Initiation Policy	42
15.1.2.1	Associated Real-World Activity.....	43
15.1.3	Association Acceptance Policy.....	47
16	<i>Communication Profiles</i>	48
16.1	Supported Communication Stacks	48
16.1.1	TCP/IP Stack	48
16.1.1.1	API.....	48
16.1.1.2	Physical Media Support.....	48
17	<i>Extensions / Specializations / Privatizations</i>	49
17.1.1	Standard Extended / Specialized / Private SOPs.....	49
17.1.2	Private Transfer Syntaxes	49
18	<i>Configuration</i>	50
18.1	AE Title/Presentation Address Mapping.....	50
18.1.1	DICOM Verification	50
18.1.2	DICOM Storage SCP AE Title	50
18.1.3	DICOM Storage SCU AE Title.....	50
18.1.4	DICOM Query/Retrieve AE Title.....	50
18.1.5	DICOM Storage Commitment AE Title	50
18.1.6	DICOM Worklist AE Title	51
18.1.7	DICOM MPPS AE Title	51
18.1.8	DICOM Print AE Title.....	51
18.2	Configurable Parameters	51
18.2.1	Storage and Query/Retrieve	51
18.2.2	Storage Commitment.....	52
18.2.3	Modality Worklist.....	52
18.2.4	Modality Performed Procedure Step	52

18.2.5	Print.....	52
18.3	Default Parameters	53
19	<i>Support of Extended Character Sets</i>	54
	<i>Application Profile Conformance Statement.....</i>	55
1	<i>Introduction.....</i>	56
1.1	Purpose.....	56
1.2	Scope	56
1.3	Definitions, Terms and Abbreviations.....	56
1.4	References.....	56
1.5	Remarks	56
2	<i>Implementation Model.....</i>	58
2.1	Application Data Flow Diagram	58
2.2	Functional Definitions of AEs	58
2.3	Sequencing of Real-World Activities.....	58
2.4	File Meta Information Options.....	59
3	<i>AE Specifications</i>	59
3.1	DICOM Archive Specification.....	59
3.1.1	File Meta Information for the Application Entity	59
3.1.2	Real-World Activities for this Application Entity	59
3.1.2.1	Real-World Activity: Browse Directory Information.....	59
3.1.2.2	Real-World Activity: Import into local Storage	59
3.1.2.3	Real-World Activity: Export to local Archive Media	60
4	<i>Augmented and Private Profiles.....</i>	62
4.1	Augmented Application Profiles.....	62
4.2	Private Application Profiles.....	62
5	<i>Extensions, Specializations and Privatizations of SOP Classes and Transfer Syntaxes</i>	63
5.1	SOP Specific Conformance Statement for Basic Directory	64
5.1.1	Extension, Specialization for "Packed CD"	64
5.1.2	DICOMDIR Attributes	64
6	<i>Configuration</i>	66
6.1	AE Title Mapping	66
6.1.1	DICOM Media Storage AE Title.....	66
7	<i>Support of Extended Character Sets</i>	67
A	<i>APPENDIX</i>	68
A.1	Common attributes in image and structured report IODs.....	68
A.2	SC Standard Extended SOP Class	70
A.3	Multiframe True Color SC Storage Standard Extended SOP Class.....	70
A.4	XRF Standard Extended SOP Class	71
A.4.1	configuration "XRF – Full"	71

A.4.2	configuration "XRF – Ready Processed"	73
A.5	CR Standard Extended SOP Class	75
A.6	X-Ray Radiation Dose SR SOP Class.....	77
A.7	EXAM Protocol as Secondary Capture Image.....	78
A.8	SOP Common Module – Image Type Extensions.....	79
A.9	Private Data	79
A.9.1	General Private Data	79
A.10	FLUOROSPOT Compact Worklist Identifier	82
A.11	Modality Performed Procedure Step Identifiers.....	85
A.12	Grayscale Image Consistency	87

Network Conformance Statement

1 Introduction

1.1 Overview

This Conformance Statement describes the DICOM network interface for Siemens X-ray acquisition modalities based on the FLUOROSPOT Compact VF30 imaging system according to part PS 3.2 of [DICOM].

This introduction describes the application's implemented DICOM functionality in general terms.

1.2 Scope and Field

The Siemens product FLUOROSPOT Compact is a multifunctional imaging system for fluoroscopic, urologic and radiographic procedures. This DICOM Conformance Statement is valid for the following products:

- Luminos dRF VC10
- Luminos Agile VC10
- Luminos Fusion VC10
- Luminos Select VC10
- Ysio VC10
- Multix Select DR VA10
- Multix DR upgrade VA20
- UROSKOP Omnia VC10

Depending of the examinations to be performed on a system the products are separated into:

- Fluorosystems:
Luminos dRF, Luminos Agile, UROSKOP Omnia, Luminos Fusion, Luminos Select
- Radsystems:¹
Ysio, Multix Select DR, Multix DR upgrade, Luminos dRF, Luminos Agile, UROSKOP Omnia

The supported DICOM Services allow a smooth integration in the clinical network. Depending on system type images can be stored utilizing the DICOM XRF, CR and Secondary Capture IOD, the DICOM service 'Storage Commitment (Push Model) Service Class' indicates established image storage in the DICOM image archive. Images, acquired at the FLUOROSPOT Compact, can be retrieved from another network node by using the DICOM service 'DICOM Query/Retrieve'. With 'DICOM Basic Worklist Management Service Class' the worklist containing patient data can be retrieved from the information system and afterwards examination data can be send back to the information by using 'Modality Performed Procedure Step Service Class'. Finally, FLUOROSPOT

¹ Fluorosystems with flat panel detector are able to perform Rad acquisitions as well and therefore are classified as Radsystems too.

Compact supports the “Print Management Service Class” and the “Media Storage Service Class” (General Purpose CDR Application Profile).

This DICOM Conformance Statement refers to FLUOROSPOT Compact based products only.

1.3 Audience

This document is intended for hospital staff, health system integrators, software designers or implementers. It is assumed that the reader has a working understanding of DICOM.

1.4 Remarks

DICOM, by itself, does not guarantee interoperability. However, the Conformance Statement facilitates a first-level validation for interoperability between different applications supporting the same DICOM functionality as SCU and SCP, respectively.

This Conformance Statement is not intended to replace validation with other DICOM equipment to ensure proper exchange of information intended.

The scope of this Conformance Statement is to facilitate communication with Siemens and other vendors' Medical equipment. The Conformance Statement should be read and understood in conjunction with the DICOM 3.0 Standard [DICOM]. It is, however, by itself not guaranteed to ensure the desired interoperability and a successful interconnectivity.

The user should be aware of the following important issues:

- The comparison of different conformance statements is the first step towards assessing interconnectivity between Siemens and non-Siemens equipment.
- Test procedures should be defined and tests should be performed by the user to validate the connectivity desired. DICOM itself and the conformance parts do not specify this.
- The standard will evolve to meet the user's future requirements. Siemens is actively involved in developing the standard further and therefore reserves the right to make changes to its products or to discontinue its delivery.
- Siemens reserves the right to modify the design and specifications contained herein without prior notice. Please contact your local Siemens representative for the most recent product information.

1.5 Definitions, Terms and Abbreviations

Definitions, terms and abbreviations used in this document are defined within the different parts of the DICOM standard.

Abbreviations and terms are as follows:

AE	DICOM Application Entity
AET	DICOM Application Entity Title
ASCII	American Standard Code for Information Interchange
CR	Computed Radiography
CSE	Customer Service Engineer
DCS	DICOM Conformance Statement
IOD	DICOM Information Object Definition
ISO	International Standard Organization
MPPS	Modality Performed Procedure Step
NEMA	National Electrical Manufacturers Association
R	Required Key Attribute
O	Optional Key Attribute
RIS	Radiology Information System
PDU	DICOM Protocol Data Unit
SC	Secondary Capture
SCU	DICOM Service Class User (DICOM client)
SCP	DICOM Service Class Provider (DICOM server)
SOP	DICOM Service-Object Pair
U	Unique Key Attribute
UI	User Interface
UID	Unique Identifier
US	Ultrasound
XRF	X-Ray Radiofluoroscopy

1.6 References

[DICOM] Digital Imaging and Communications in Medicine (DICOM), NEMA PS 3.1-3.18, 2010

1.7 Structure

The FLUOROSPOT Compact Conformance Statement is subdivided into three Parts which relate to individual documents needed to declare Conformance according to the requirements of “Part 2 – Conformance” of the DICOM Standard.

Those parts are:

- “DICOM Conformance Statement” for Network related Services
- “Offline Media Conformance Statement” to support local archive media.
- A general Appendix.

2 Implementation Model Verification

The FLUOROSPOT Compact DICOM application requests Verification to verify the ability of an other DICOM application on a remote node to respond to DICOM messages.

Responding to Verification requests from remote nodes is handled by the Storage SCP application.

2.1 Application Data Flow Diagram

The FLUOROSPOT Compact DICOM network implementation is a Windows XP application and acts as SCU for the C-ECHO DICOM network service.

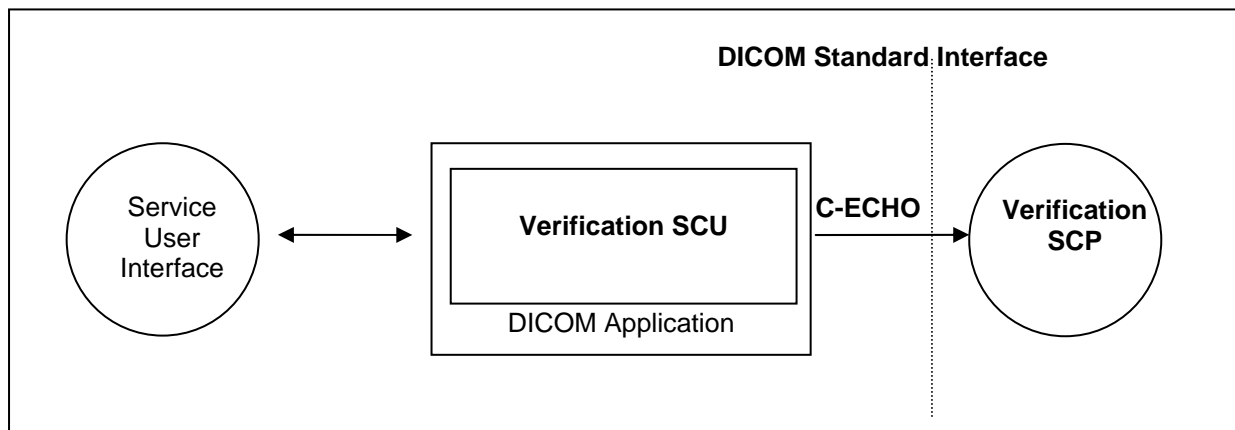

Figure 1: FLUOROSPOT Compact Application Flow Diagram – Verification SCU

2.2 Functional Definitions of Applications

The Siemens FLUOROSPOT Compact DICOM application opens an association when a “C-ECHO” of a remote application is requested from the Service User Interface. This can be done to verify the correct setup of a remote destinations configuration data.

2.3 Sequencing of Real-World Activities

Not applicable

3 Application Entity Specification Verification

3.1 Verification AE Specification

3.1.1 Association Establishment Policies

3.1.1.1 General

The Siemens FLUOROSPOT Compact DICOM application attempts to open an association for verification request whenever the “C-Echo” function is activated.

3.1.1.2 Number of Associations

The Siemens FLUOROSPOT Compact DICOM application initiates one association at a time to request verification.

3.1.1.3 Asynchronous Nature

The Siemens FLUOROSPOT Compact DICOM software does not support asynchronous communication (multiple outstanding transactions over a single association).

3.1.1.4 Implementation Identifying Information

Implementation Class UID	1.3.12.2.1107.5.3.4
Implementation Version Name	Siemens_FLC_60

3.1.2 Association Initiation Policy

The Siemens FLUOROSPOT Compact DICOM application attempts to initiate a new association for

- DIMSE C-ECHO service operations.

3.1.2.1 Associated Real-World Activity

3.1.2.1.1 Associated Real-World Activity – C-Echo

The associated Real-World activity is a C-ECHO request initiated by Service User Interface environment whenever a verification of a destination configuration is requested. If an association to a remote Application Entity is successfully established, verification with the configured AET is requested via the open association. If the C-ECHO Response from the remote Application is received, a message will be displayed indicating that the C–Echo was successful, and the association is closed.

3.1.2.1.2 Proposed Presentation Contexts

The Siemens FLUOROSPOT Compact DICOM application will propose Presentation Contexts as shown in the following table:

Presentation Context Table – Verification SCU					
Abstract Syntax		Transfer Syntax		Role	Ext. Neg.
Name	UID	Name List	UID List		
Verification	1.2.840.10008.1.1	Implicit VR Little Endian Explicit VR Big Endian Explicit VR Little Endian	1.2.840.10008.1.2 1.2.840.10008.1.2.2 1.2.840.10008.1.2.1	SCU	None

3.1.2.1.3 SOP Specific Conformance – Verification SCU

None.

3.1.3 Association Acceptance Policy

The Verification SCP is part of the Storage SCP – see section 5.1.3.

4 Implementation Model Storage

The Siemens FLUOROSPOT Compact DICOM Application Entity originates associations for Storage of DICOM Composite Information Objects in Remote Application Entities and receives association requests for Storage from Remote Application Entities.

“Send to...” is performed on the user’s request for each study completed or for specific images selected.

“Send to...” can also be performed for images, which are deleted (copy to Recycle Bin) but have not been archived yet.

4.1 Application Data Flow Diagram

The FLUOROSPOT Compact DICOM network implementation is a Windows XP application and acts as SCU and SCP for the C-STORE DICOM network service and as SCP for the C-ECHO DICOM network service.

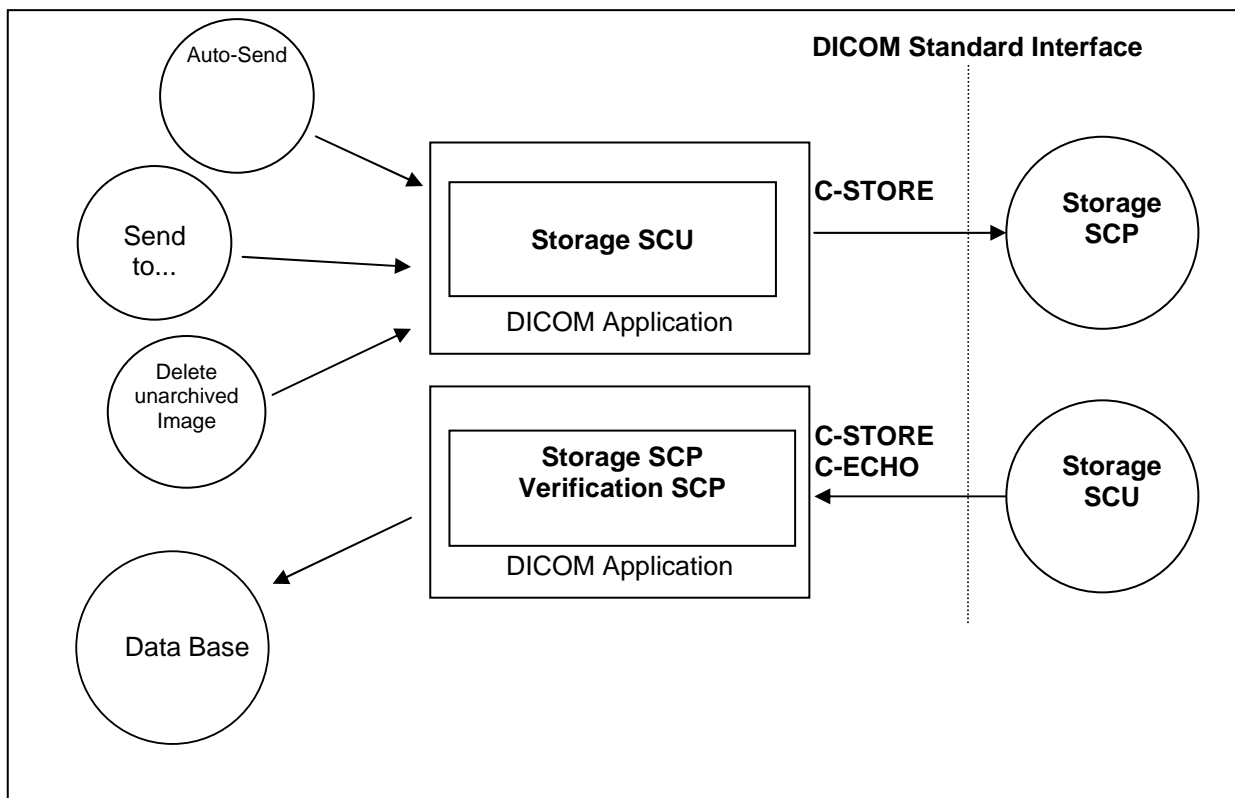

Figure 2: FLUOROSPOT Compact Application Data Flow Diagram – Storage SCU/SCP, Verification SCP

4.2 Functional Definitions of Application Entities

With “Send to...” the marked images can be sent to multiple destinations (up to 3). Each request is forwarded to the job queue and processed individually. For each destination it can be configured during Service session which IOD type (selection depending on system type) has to be used when sending images. For multiple destinations it is required, that all of the desired destination will support the same IOD type. If this is not the case, then only one target at a time can be addressed.

With “Send to...” also the “Exam Protocol as Secondary Captured Image” and the DICOM Dose Structured Report can be send to defined network destinations.

With “Auto Send” the “Send To...” mechanism is invoked automatically for a set predefined or marked images. The rules and destinations for “Auto Send” can be configured in the OGP editor and can be specified for each OGP.

With “Delete unarchived image” a image will be copied into the local Recycle Bin. Additionally for this image a “Send To...” could be invoked to a selected DICOM node.

The Storage SCU is invoked by the job control interface that is responsible for processing network archival tasks. The job consists of data describing the composite image objects marked for storage and the destination. An association is negotiated with the destination application entity and the image data is transferred using the C-STORE DIMSE-Service. Status of the transfer is reported through the job control interface. Only one job will be active at a time.

The Storage SCP component of the Siemens FLUOROSPOT Compact DICOM application is operating as background server process. It is running when the system is triggered to import images and waits then for Storage association requests. Upon accepting an association with a negotiated Presentation Context it starts to receive the Composite Image Objects and imports them to local database.

Verification requests will be processed and responded by the Storage SCP.

4.3 Sequencing of Real-World Activities

not applicable

5 Application Entity Specification Storage

5.1 Storage AES Specification

The FLUOROSPOT Compact Storage service class user/service class provider applications use two different AETs when initiating/receiving associations to/from remote DICOM nodes.

The FLUOROSPOT Compact imaging system supports several SIEMENS X-Ray acquisition modalities. SOP Classes used for storage depend on the acquisition system. For all systems FLUOROSPOT Compact provides Standard Conformance to the following DICOM SOP Classes as SCU:

SOP Class Name	SOP Class UID
Secondary Capture Image Storage	1.2.840.10008.5.1.4.1.1.7
X-Ray Radiation Dose SR	1.2.840.10008.5.1.4.1.1.88.67
X-Ray Radiofluoroscopic Image Storage (only for Fluorosystems)	1.2.840.10008.5.1.4.1.1.12.2
Computed Radiography Image Storage (only for Radsystems)	1.2.840.10008.5.1.4.1.1.1
Multi-frame True Color Secondary Capture Image Storage (only for UROSKOP Omnia)	1.2.840.10008.5.1.4.1.1.7.4

SIEMENS FLUOROSPOT Compact imaging system provides Standard Conformance to the following DICOM SOP Classes as SCP:

SOP Class Name	SOP Class UID
Secondary Capture Image Storage	1.2.840.10008.5.1.4.1.1.7
X-Ray Radiofluoroscopic Image Storage (only for Fluorosystems)	1.2.840.10008.5.1.4.1.1.12.2
Computed Radiography Image Storage (only for Radsystems)	1.2.840.10008.5.1.4.1.1.1
Multi-frame True Color Secondary Capture Image Storage (only for UROSKOP Omnia)	1.2.840.10008.5.1.4.1.1.7.4
Verification	1.2.840.10008.1.1

5.1.1 Association Establishment Policies

5.1.1.1 General

The existence of a job queue entry with network destination will activate the DICOM Storage Application. An association request is sent to the destination AE and upon successful negotiation of a Presentation Context the transfer is started. If the association can not be opened, the related job is set to an error state and can be restarted by user job control interface. It is configurable by the CSE if a retry for failed jobs is initiated automatically.

The default PDU size used will be 64 KB.

5.1.1.2 Number of Associations

The FLUOROSPOT Compact DICOM application initiates one association at a time, subsequently for each destination to which a transfer request is being processed in the active job queue list. Only one job will be active at a time, the other remain pending until the active job is completed or failed.

5.1.1.3 Asynchronous Nature

The FLUOROSPOT Compact software does not support asynchronous communication (multiple outstanding transactions over a single association).

5.1.1.4 Implementation Identifying Information

Implementation Class UID	1.3.12.2.1107.5.3.4
Implementation Version Name	Siemens_FLC_60

5.1.2 Association Initiation Policy

If a job with network destination gets active in the job list the FLUOROSPOT Compact DICOM application attempts to initiate a new association for

- DIMSE C-STORE service operations.

5.1.2.1 Associated Real-World Activity – Storage SCU

5.1.2.1.1 Associated Real-World Activity –Send to ...

The associated Real-World activity is a C-STORE request initiated by an internal daemon process triggered by a job with network destination. If the process successfully establishes an association to a remote Application Entity, it will transfer each marked image one after another via the open association. The used storage IOD is depending on the system type and on the destination's configuration. If the C-STORE Response from the remote Application contains a status other than Success or Warning, the association is aborted. The related job is switched to a failed state. It can be restarted any time by user interaction. An automatic retry can be configured by the CSE.

Processing of images of a send job and sending of processed images is done in parallel. That means, as soon as the first image of a job is processed an association is initiated and the sending of the processed image is started.

An established association is closed as soon as no processed image is available to be sent.

Due to different speeds of sending and processing the FLUOROSPOT Compact might initiate more than one association for each send job!

5.1.2.1.2 Proposed Presentation Context –Send to...

The FLUOROSPOT Compact DICOM application will propose Presentation Contexts as shown in the following table:

Presentation Context Table					
Abstract Syntax		Transfer Syntax		Role	Ext. Neg.
Name	UID	Name List	UID List		
Computed Radiography Image Storage Service Class	1.2.840.10008.5.1.4.1.1.1	Implicit VR Little Endian Explicit VR Big Endian Explicit VR Little Endian	1.2.840.10008.1.2 1.2.840.10008.1.2.2 1.2.840.10008.1.2.1	SCU	None
Secondary Capture Image Storage Service Class	1.2.840.10008.5.1.4.1.1.7	Implicit VR Little Endian Explicit VR Big Endian Explicit VR Little Endian	1.2.840.10008.1.2 1.2.840.10008.1.2.2 1.2.840.10008.1.2.1	SCU	None
X-Ray Radiation Dose SR	1.2.840.10008.5.1.4.1.1.88.67	Implicit VR Little Endian Explicit VR Big Endian Explicit VR Little Endian	1.2.840.10008.1.2 1.2.840.10008.1.2.2 1.2.840.10008.1.2.1	SCU	None
X-Ray Radiofluoroscopic Image Storage Service Class	1.2.840.10008.5.1.4.1.1.12.2	Implicit VR Little Endian Explicit VR Big Endian Explicit VR Little Endian	1.2.840.10008.1.2 1.2.840.10008.1.2.2 1.2.840.10008.1.2.1	SCU	None
Multi-frame True Color Secondary Capture Image Storage	1.2.840.10008.5.1.4.1.1.7.4	Implicit VR Little Endian Explicit VR Big Endian Explicit VR Little Endian	1.2.840.10008.1.2 1.2.840.10008.1.2.2 1.2.840.10008.1.2.1	SCU	None

If multiple destinations are addressed within one network job, then all of those are required to support the same IOD.

5.1.2.1.3 SOP specific Conformance Statement –Send to...

The DICOM images created by the DICOM interface of the FLUOROSPOT Compact conform to the DICOM CR, XRF, Secondary Capture or Multi-frame True Color Secondary Capture IOD definitions. Private elements are contained in the objects. The IODs will be a Standard Extended Image Storage SOP Classes.

The DICOM Dose Structured Report created by the DICOM interface of the FLUOROSPOT Compact conforms to the X-Ray Radiation Dose SR IOD definitions. Private elements are contained in the objects.

5.1.2.1.3.1 Optional Attributes

A list of all DICOM IOD attributes of type 2 and 3 which are encoded by the FLUOROSPOT Compact applications can be found in the APPENDIX (page 68 ff).

5.1.2.1.3.2 Image Pixel Attribute Description for Grayscale Images

The Siemens FLUOROSPOT Compact DICOM application supports the “MONOCHROME 2” Photometric Interpretation with the unsigned integer 16-bit (8 bit for downsized images) gray scale pixel and graphic overlay format. The lower 12 (8 bit for downsized images) bits are used for pixel and bit 16 might be used for the graphic overlay:

Pixel plane

Image Type		Samples per Pixel (0028, 0002)	Photometric Interpretation (0028,0004)	Rows (0028, 0010)	Columns (0028, 0011)	Bits Allocated (0028, 0100)	Bits Stored (0028, 0101)	High Bit (0028, 0102)	Pixel Representation (0028, 0103)
Detector	DFR Zoom 0	1	MONOCHROME2	1440	1440	16	12	11	0
	DFR Zoom 1	1	MONOCHROME2	1024	1024	16	12	11	0
	DFR Zoom 2	1	MONOCHROME2	768	768	16	12	11	0
	DFR Zoom 3	1	MONOCHROME2	1024	1024	16	12	11	0
	Store Fluoro/LIH Zoom 0	1	MONOCHROME2	960	960	16	12	11	0
	Store Fluoro/LIH Zoom 1	1	MONOCHROME2	1024	1024	16	12	11	0
	Store Fluoro/LIH Zoom 2	1	MONOCHROME2	768	768	16	12	11	0
	Store Fluoro/LIH Zoom 3	1	MONOCHROME2	1024	1024	16	12	11	0
	Fluoro Zoom 0/ downscaled	1	MONOCHROME2	480	480	8	8	7	0
	Fluoro Zoom 1/ downscaled	1	MONOCHROME2	512	512	8	8	7	0
	Fluoro Zoom 2/ downscaled	1	MONOCHROME2	384	384	8	8	7	0
	Fluoro Zoom 3/ downscaled	1	MONOCHROME2	512	512	8	8	7	0
I.I.	DFR	1	MONOCHROME2	1024	1024	16	12	11	0
	Store Fluoro / LIH	1	MONOCHROME2	1024	1024	16	12	11	0
	Store Fluoro/ downscaled	1	MONOCHROME2	512	512	8	8	7	0
Radiographic image (RAD)		1	MONOCHROME2	up to 3056	up to 3056	16	12	11	0
Composing image (RAD)		1	MONOCHROME2	up to 12000	up to 3056	16	12	11	0
TWIN view image		1	MONOCHROME2	1024	1024	8	8	7	0
QUAD view image		1	MONOCHROME2	2048	2048	8	8	7	0
Exam Protocol as Image		1	MONOCHROME2	2100	2970	16	12	11	0

Overlay plane (only used with XRF full)

- Overlay Type (attribute 60xx, 0040) = "G"
- Bits Allocated (attribute 60xx, 0100) = 16 if (0028,0100) = 16, or 1 if (0028,0100) = 8
- Bit Position (attribute 60xx, 0102) = 16 if (60xx, 0100) = 16 or 0 if (60xx, 0100) = 1
- Overlay Data (attribute 60xx, 3000) = is used if (0028,0100) = 8

5.1.3 Association Acceptance Policy

The FLUOROSPOT Compact DICOM application attempts to accept a new association for

- DIMSE C-ECHO
- DIMSE C-STORE

service operations. Any Information Objects transmitted on that association will be checked on conformance and stored in database if check was successful.

5.1.3.1 Associated Real-World Activity – Storage SCP

5.1.3.1.1 Associated Real-World Activity – Receiving Images from a Remote Node (with Retrieve)

Receiving is possible whenever an import request (C-MOVE) is sent to a remote destination. As long as it is active, the receiver process will accept an association and will receive images transmitted on that association and will store the images on disk in the own data base if the conformance check is performed successfully.

The FLUOROSPOT Compact DICOM application is designed for retrieving images that were acquired by the system itself.

The FLUOROSPOT Compact DICOM application will accept Presentation Contexts as shown in the following table:

Presentation Context Table					
Abstract Syntax		Transfer Syntax		Role	Ext. Neg.
Name	UID	Name List	UID List		
Computed Radiography Image Storage Service Class	1.2.840.10008.5.1.4.1.1.1	Implicit VR Little Endian Explicit VR Big Endian Explicit VR Little Endian	1.2.840.10008.1.2 1.2.840.10008.1.2.2 1.2.840.10008.1.2.1	SCP	None
Secondary Capture Image Storage Service Class	1.2.840.10008.5.1.4.1.1.7	Implicit VR Little Endian Explicit VR Big Endian Explicit VR Little Endian	1.2.840.10008.1.2 1.2.840.10008.1.2.2 1.2.840.10008.1.2.1	SCP	None
X-Ray Radiofluoroscopic Image Storage Service Class	1.2.840.10008.5.1.4.1.1.12.2	Implicit VR Little Endian Explicit VR Big Endian Explicit VR Little Endian	1.2.840.10008.1.2 1.2.840.10008.1.2.2 1.2.840.10008.1.2.1	SCP	None
Multi-frame True Color Secondary Capture Image Storage Class	1.2.840.10008.5.1.4.1.1.7.4	Implicit VR Little Endian Explicit VR Big Endian Explicit VR Little Endian	1.2.840.10008.1.2 1.2.840.10008.1.2.2 1.2.840.10008.1.2.1	SCP	None
Verification	1.2.840.10008.1.1	Implicit VR Little Endian Explicit VR Big Endian Explicit VR Little Endian	1.2.840.10008.1.2 1.2.840.10008.1.2.2 1.2.840.10008.1.2.1	SCP	None

5.1.3.1.2 SOP-specific Conformance Statement – Receiving Images from a Remote Node (with Retrieve)

The FLUOROSPOT Compact DICOM application conforms to the Full Storage Class at Level 1. In the event of a successful C-STORE operation, the image has successfully been written on disk.

The FLUOROSPOT Compact DICOM receiver returns the status Success upon successful operation otherwise one of the following status codes is returned and the association is aborted:

- Refused (A700):
This error status indicates a lack of Resources (e.g. not enough disk space) on the FLUOROSPOT Compact modality.
- Error (A900 or C000):
An error occurred while processing the image that makes it impossible to proceed. The image will not be stored and the association aborted.

If an image instance is received that is identified by a SOP Instance UID that is already used by an Instance stored in database then the actual received image will be refused. The existing Instance is not superseded.

5.1.3.1.2.1 Image Pixel Attribute Description for Receiving of Grayscale Images

The FLUOROSPOT Compact DICOM receiver supports images of the CR, XRF or Secondary Capture Image Storage SOP class. The following restrictions to supported pixel data apply:

- Only images generated by a FLUOROSPOT Compact imaging system are supported.

5.1.3.1.3 Presentation Context Acceptance Criterion

The FLUOROSPOT Compact DICOM application will accept any number of verification or storage SOP classes that are listed above. The number of presentation contexts accepted is limited to the maximum of 127 (DICOM limit). In the event that the FLUOROSPOT Compact DICOM application runs out of resources, it will reject the association request.

5.1.3.1.4 Transfer Syntax Selection Policies

The FLUOROSPOT Compact DICOM application currently supports the Implicit VR Little Endian, the Explicit VR Little Endian and Explicit VR Big Endian Transfer Syntaxes

Any proposed presentation context including one of these transfer syntaxes will be accepted. Any proposed presentation context that does not include one of these transfer syntaxes will be rejected. Explicit Little Endian Transfer Syntax will be preferred over the implicit Default Transfer Syntax.

The FLUOROSPOT Compact DICOM application will remove any Private Attributes not known to the application.

6 Implementation Model Storage Commitment

The Storage Commitment Service Class defines an application-level class-of-service that facilitates commitment of storage. The Storage Commitment Service Class enables an Application Entity (AE) acting as SCU to request another Application Entity (AE) acting as an SCP to make the commitment for the safekeeping of the SOP Instances (i.e. that the SOP Instances will be kept for an implementation specific period of time and can be retrieved).

The FLUOROSPOT Compact DICOM application will support the Storage Commitment Push Model SOP Class as SCU.

6.1 Application Data Flow Diagram

“Send Image complete” is performed as a result of a completed Storage request. Successful completion of a Send to... request will result in automated initiation of a Storage Commitment Service. Each request results in an initiation for an association. The association will be closed after a maximum of 10 seconds (configurable in Service) of waiting for the response. After that receiving the Storage Commitment status is expected on a different association.

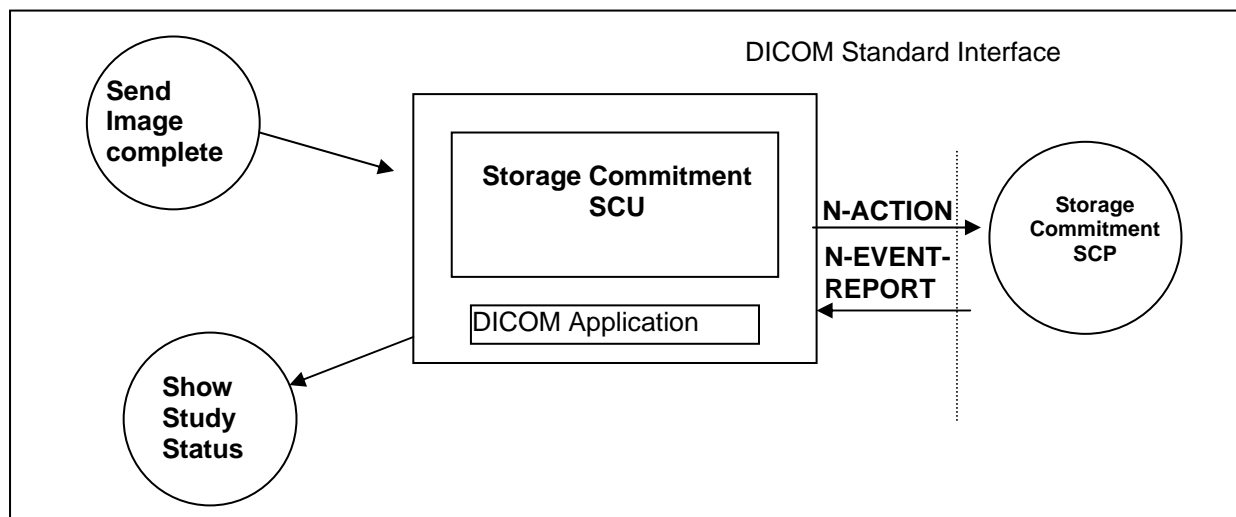

Figure 3: FLUOROSPOT Compact Application Data Flow Diagram – Storage Commitment

6.2 Functional Definitions of Application Entities

With each “send operation” successfully completed the FLUOROSPOT Compact DICOM Application will create a Storage Commitment Push Model Identifier from the SOP Instances sent. Then a Storage Commit Request is triggered. The FLUOROSPOT Compact will wait up to 10 seconds for responses, after that it expects the related response-trigger on a different association.

The commitment status derived from the related trigger response will be indicated in the Study list. Additionally the status will be evaluated previously to delete operations to inform the user about possible loss of information due to incomplete send operations and/or commit failures.

In any case, commitment will only be requested for previously and successfully sent images.

Storage Commitment is possible to different configured network nodes. Each Storage SCP can have its own Storage Commitment Server associated.

6.3 Sequencing of Real-World Activities

The Storage Commitment trigger is automatically derived from the successful completion of a Send operation.

7 AE Specification Storage Commitment

7.1 Storage Commitment AE Specification

The FLUOROSPOT Compact DICOM application will use one AE when performing Storage Commitment request and when awaiting notification from the Storage Commitment Provider.

SIEMENS FLUOROSPOT Compact DICOM products provide Standard Conformance to the following DICOM V3.0 SOP Classes as SCU:

SOP Class Name	SOP Class UID
Storage Commitment Push Model	1.2.840.10008.1.20.1

7.1.1 Association Establishment Policies

7.1.1.1 General

The DICOM application will generate a Storage Commitment Identifier which references to all Instances of a selected study in the scope of the FLUOROSPOT Compact application. The request is then sent over a single opened association. The FLUOROSPOT Compact will wait for status responses to the Storage Commitment Request. If the Provider accepts the Storage Commitment with Success status, the generated Transaction UID, together with study identification data and a time-stamp, is kept in a Pending Request Queue. The association is then closed. Multiple Storage Commitment Requests can be hold in the Pending Request Queue.

The default PDU size used will be 64 KB.

7.1.1.2 Number of Associations

The FLUOROSPOT Compact will initiate one association to send Storage Commitment requests to a configured Archive destination.

7.1.1.3 Asynchronous Nature

The FLUOROSPOT Compact DICOM software does not support asynchronous communication (multiple outstanding transactions over a single association).

7.1.1.4 Implementation Identifying Information

Implementation Class UID	1.3.12.2.1107.5.3.4
Implementation Version Name	Siemens_FLC_60

7.1.2 Association Initiation Policy

If a Storage Commitment Request needs to be sent to an Archive destination the FLUOROSPOT Compact DICOM application attempts to initiate a new association for

- DIMSE N-ACTION service operations.

7.1.2.1 Real World Activity – Storage Commitment SCU

7.1.2.1.1 Associated Real-World Activity – Send Image Complete

Whenever a Store Request to a Storage SCP with associated Storage Commitment SCP is completed in the job queue, a Storage Commitment Identifier is generated for the same scope of Instances as transferred through the successful Storage Request. The identifier is then sent with the N-ACTION service to the Storage Commitment SCP. The association will wait up to 10 seconds for responses after the Storage Commitment Provider accepted the request. Storage Commitment SCP nodes can be configured by the CSE.

A number of retries for failed commit requests and a Storage Commitment timeout can be configured in User Settings.

7.1.2.1.2 Proposed Presentation Contexts –Send Image Complete

The FLUOROSPOT Compact DICOM application will propose Presentation Contexts as shown in the following table:

Presentation Context Table					
Abstract Syntax		Transfer Syntax		Role	Ext. Neg.
Name	UID	Name List	UID List		
Storage Commitment Push Model	1.2.840.10008.1.20.1	Implicit VR Little Endian Explicit VR Big Endian Explicit VR Little Endian	1.2.840.10008.1.2 1.2.840.10008.1.2.2 1.2.840.10008.1.2.1	SCU	None

7.1.2.1.3 SOP-specific Conformance Statement – Send Image Complete

The FLUOROSPOT Compact DICOM application will NOT support the Storage Media File Set ID attributes.

SIEMENS FLUOROSPOT Compact DICOM application will request Storage commitment for the following SOP Classes as SCU:

SOP Class Name	SOP Class UID
Computed Radiography Image Storage (only for Radsystems)	1.2.840.10008.5.1.4.1.1.1
Secondary Capture Image Storage	1.2.840.10008.5.1.4.1.1.7
X-Ray Radiofluoroscopic Image Storage (only for Fluorosystems)	1.2.840.10008.5.1.4.1.1.12.2

7.1.3 Association Acceptance Policy

The FLUOROSPOT Compact Storage Commitment DICOM application attempts to accept a new association for

- DIMSE N-EVENT-REPORT service operations.

7.1.3.1 Real World Activity – Storage Commitment SCU

7.1.3.1.1 Associated Real-World Activity – Show Study Status

Consecutive to start-up, the FLUOROSPOT Compact DICOM application will await Storage commitment Notification triggers. Any incoming Notification will be checked for validity, that is, if the related Transaction UID is still part of the Pending Request Queue. If not, the related Notification trigger is rejected with an “Unable to process” error. The related study is already set to commit failed due to time-out on notification.

If the Notification is valid, the Notification Identifier is evaluated and the related Instances are marked with the related status. The over-all Commit Status of the study is derived from propagation of the States of all instances included by a study.

The Study Status indicated in the Study list can be one of

- <no Status> (-) [not sent or send failed]
- Sent (S) [all images successfully sent to DICOM Send node, commitment successful for the complete study]
- Partially Sent (s) [some or all instances of the Study successfully sent to DICOM Send node, commitment outstanding for at least 1 image of the study]
- Archived (A) [all images successfully sent to Archive node, commitment successful for the complete study]
- Partially Archived (a) [some or all instances of the Study successfully sent to Archive node, commitment outstanding for at least 1 image of the study]

The FLUOROSPOT Compact delete function will be sensitive on the Study Status and will protect Studies. The user can override the protection by confirming the respective delete dialogues.

In case of failure the user has to repeat the transfer of images to the Archive destination. Another Storage Commitment will be performed after sending is completed successfully.

7.1.3.1.2 Accepted Presentation Contexts –Show Study Status

The FLUOROSPOT Compact DICOM application will accept Presentation Contexts as shown in the following table:

Presentation Context Table					
Abstract Syntax		Transfer Syntax		Role	Ext. Neg.
Name	UID	Name List	UID List		
Storage Commitment Push Model	1.2.840.10008.1.20.1	Implicit VR Little Endian Explicit VR Big Endian Explicit VR Little Endian	1.2.840.10008.1.2 1.2.840.10008.1.2.2 1.2.840.10008.1.2.1	SCU *1	None

*1 according to the rules defined for Storage Commitment N-EVENT-REPORT, the FLUOROSPOT Compact itself assumes the SCU role and therefore accepts the SCP role negotiation of the Storage Commitment Provider, even if initiator of the association negotiation.

7.1.3.1.3 SOP-specific Conformance Statement – Show Study Status

The FLUOROSPOT Compact DICOM application will NOT support the Storage Media File Set ID attributes.

8 Implementation Model Query / Retrieve

The query/retrieve service class defines an application-level class of services that facilitates the management of images and patient data against the well-defined information model of DICOM and allows a DICOM AE to retrieve images from a remote DICOM node. The FLUOROSPOT Compact DICOM query/retrieve application supports the query/retrieve services to act as SCU.

8.1 Application Data Flow Diagram

The FLUOROSPOT Compact DICOM network implementation is a Windows XP application and acts as SCU for the query/retrieve network service.

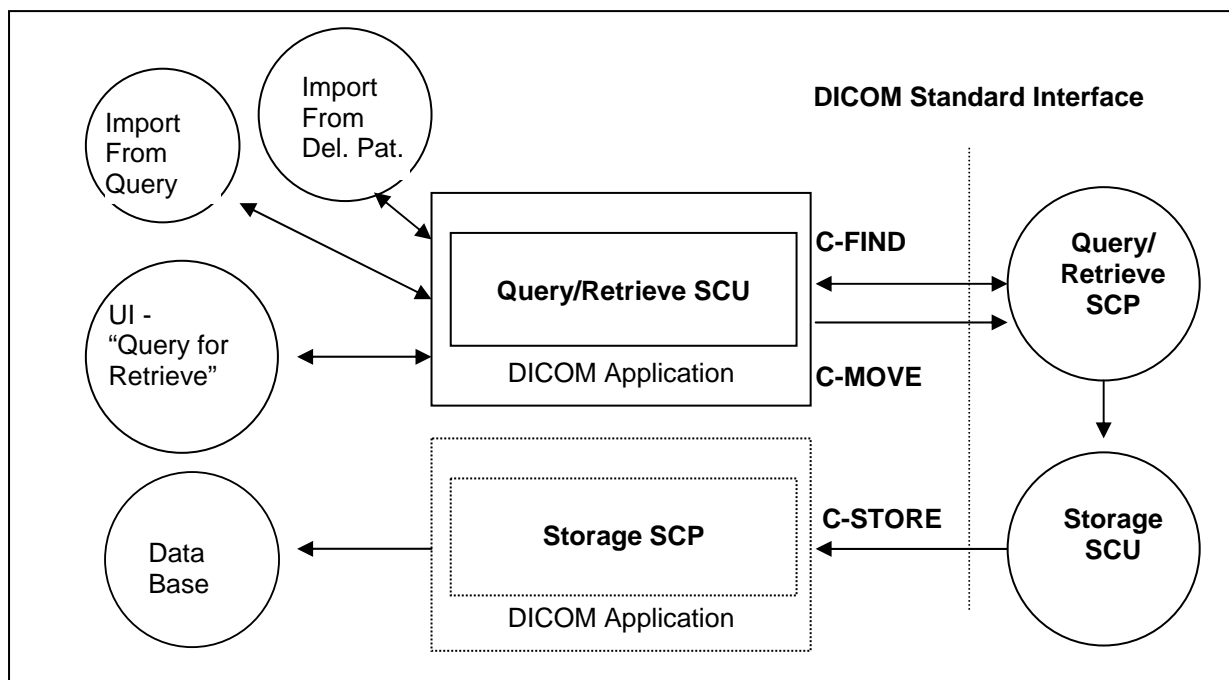

Figure 4: FLUOROSPOT Compact Application Data Flow Diagram – Query/Retrieve SCU

8.2 Functional Definitions of Application Entities

The FLUOROSPOT Compact DICOM query/retrieve SCU requests the remote query/retrieve SCP to perform a search (C-FIND) and match to the keys specified in the request in order to display the results in the FLUOROSPOT Compact user interface. If the defined limit of Query results is reached, the FLUOROSPOT Compact will cancel the running query and discard any further incoming query result responses. Queries can be operated in parallel to one running import (C-MOVE) activity.

Depending on user action (Import) the FLUOROSPOT Compact DICOM query/retrieve SCU sends a C-MOVE DIMSE service to initiate a C-STORE sub-operation on the SCP to start an image transfer from remote Storage SCU (running on Query/Retrieve SCP) to the FLUOROSPOT Compact Storage SCP. The user has the possibility to cancel a running import by an "Import Cancel" function. The FLUOROSPOT Compact DICOM application will perform only one running import operation at a time.

8.3 Sequencing of Real-World Activities

Import operation has to be completed or successfully canceled before a new import can be initiated at the user interface.

9 AE Specification Query/Retrieve

9.1 Query/Retrieve Service AEs Specification

The Query/Retrieve SCU requests that the remote SCP performs a match of all keys specified in the request, against the information in its database.

SIEMENS FLUOROSPOT Compact DICOM products provide Standard Conformance to the following DICOM SOP Classes as SCU:

SOP Class Name	SOP Class UID
Study Root Query/Retrieve Information Model – FIND	1.2.840.10008.5.1.4.1.2.2.1
Study Root Query/Retrieve Information Model – MOVE	1.2.840.10008.5.1.4.1.2.2.2

9.1.1 Association Establishment Policies

9.1.1.1 General

With the “Query for Retrieve” function the query data are input and the DICOM query/retrieve application is started. A query request will be sent out to the selected remote node and the response data will be displayed for the user. Upon request (Import), the retrieval of selected items is initiated.

Running Query requests will be automatically canceled whenever the defined limit has been reached. A running import can be canceled upon user’s request.

The default PDU size used will be 64 KB.

9.1.1.2 Number of Associations

The FLUOROSPOT Compact DICOM application initiates one association for each query request being processed to a remote node. Only one Import (C-MOVE) request can be active at a time.

9.1.1.3 Asynchronous Nature

The FLUOROSPOT Compact DICOM software does not support asynchronous communication (multiple outstanding transactions over a single association).

9.1.1.4 Implementation Identifying Information

Implementation Class UID	1.3.12.2.1107.5.3.4
Implementation Version Name	Siemens_FLC_60

9.1.2 Association Initiation Policy

The query user interface will request the query-data (combined input of patient- and study-related data) from user and triggers one or more C-FIND request to the selected remote node. The response data will be displayed in the query UI as a combined Patient/Study list. Navigation (further queries) to Series-Level is supported by the FLUOROSPOT Compact, navigation to Image-Level is not supported. A running Query will be canceled (C-CANCEL) by the DICOM Application if the response limit has been reached.

When requesting Import of a related item, the browser requests the DICOM retrieve application to send a C-MOVE request to the related remote node. SOP Instances will then be received by the Storage SCP as described in the related section. An import can be terminated by user request (C-CANCEL).

9.1.2.1 Real World Activity – Find SCU

9.1.2.1.1 Associated Real-World Activity – Query for Retrieve

The associated Real-World activity is to fill out a query form with search data and pass it as a query request to the network application that issues one or more C-FIND requests over a previously built association. The remote SCP will respond with related data-entries that will be passed to a browser application. When data transfer is finished, the association is closed.

In case of error, the list is built up to the point where the error occurred. The user is informed about incomplete processing of the query results.

9.1.2.1.2 Proposed Presentation Contexts – Query for Retrieve

The FLUOROSPOT Compact DICOM application will propose Presentation Contexts as shown in the following table:

Presentation Context Table					
Abstract Syntax		Transfer Syntax		Role	Ext. Neg.
Name	UID	Name List	UID List		
Study Root Query/Retrieve Model – FIND	1.2.840.10008.5.1.4.1.2.2.1	Implicit VR Little Endian Explicit VR Big Endian Explicit VR Little Endian	1.2.840.10008.1.2 1.2.840.10008.1.2.2 1.2.840.10008.1.2.1	SCU	None

Extended Negotiation to request “relational query” is not supported by the FLUOROSPOT Compact DICOM application.

9.1.2.1.3 SOP Specific Conformance Statement – Query for Retrieve

The FLUOROSPOT Compact DICOM Query/Retrieve SCU supports hierarchical queries with the search keys listed below. The Query SCU does not support the interactive querying of attributes on IMAGE level. The following table describes the matching keys/ return keys that the SCU supports:

Attribute Name	Tag	Type	Matching	User Input	Return Value Display
Patient Level					
Patient's Name ²	(0010,0010)	R	Wildcard	Enter value	Yes
Patient ID	(0010,0020)	U / R	Wildcard	Enter value	Yes
Patient's Birth Date	(0010,0030)	O	Universal (Null)	Enter value	Yes
Patient's Sex	(0010,0040)	O	Universal (Null)	Select value	Yes
Study Level					
Study Instance UID	(0020,000D)	U	Universal (Null) / Single Value	-- / Select from List	-- / Yes
Study ID	(0020,0010)	R	Universal (Null)	Enter value	No
Study Date	(0008,0020)	R	Universal (Null)	--	Yes
Study Time	(0008,0030)	R	Universal (Null)	--	Yes
Accession Number	(0008,0050)	R	Universal (Null)	Enter value	Yes
Study Description	(0008,1030)	O	Universal (Null)	--	Yes
Number of Study Related Series	(0020,1206)	O	Universal (Null)	--	Yes
Number of Study Related Instances	(0020,1208)	O	Universal (Null)	--	Yes
Series Level					
Series Instance UID	(0020,000e)	U	Single Value	Select from List	Yes
Series Number	(0020,0011)	R	Universal (Null)	--	Yes
Modality	(0008,0060)	R	Universal (Null)	--	Yes
Number of Series Related Instances	(0020,1209)	O	Universal (Null)	--	Yes
Series Description	(0008,103e)	O	Universal (Null)	--	Yes

The Find SCU interprets following status codes:

Service Status	Meaning	Error Codes	Related Fields
Refused	Out of Resources	A700	(0000,0902)
Failed	Identifier does not match SOP Class	A900	(0000,0901) (0000,0902)
	Unable to process	Cxxx	(0000,0901) (0000,0902)
Cancel	Matching terminated due to Cancel request	FE00	None
Success	Matching is complete – No final Identifier is supplied	0000	None
Pending	Matches are continuing – Current Match is supplied and any Optional Keys were supported in the same manner as Required Keys	FF00	Identifier
	Matches are continuing – Warning that one or more Optional Keys were not supported for existence and/or matching for this identifier	FF01	Identifier

² In the Patient Name always a "*" is added

9.1.2.2 Real-World Activity – Move SCU

9.1.2.2.1 Associated Real-World Activity – Import from Query

When selecting a data entry in the Query UI and activating the “Import” function, a retrieval request is passed to the archival application that issues a C-MOVE service according to the Study Root query model. (The Storage Service Class Conformance Statement SCP section describes the response behavior to the C-STORE request sub-operation that is generated by the SCP when processing the C-MOVE request.)

The transferred image data are processed as described in the Storage Class SCP descriptions.

The possibility to request the remote C-MOVE provider (remote application that responded to the C-FIND) to move data to an application entity other than the C-STORE_SCP (the FLUOROSPOT Compact DICOM application) is NOT USED.

9.1.2.2.2 Proposed Presentation Contexts – Import from Query

The FLUOROSPOT Compact DICOM application will propose Presentation Contexts as shown in the following table:

Presentation Context Table					
Abstract Syntax		Transfer Syntax		Role	Ext. Neg.
Name	UID	Name List	UID List		
Study Root Query/Retrieve Model – MOVE	1.2.840.10008.5.1.4.1.2.2.2	Implicit VR Little Endian Explicit VR Big Endian Explicit VR Little Endian	1.2.840.10008.1.2 1.2.840.10008.1.2.2 1.2.840.10008.1.2.1	SCU	None

9.1.2.2.3 SOP Specific Conformance Statement – Import from Query

At association establishment time the C-MOVE presentation context shall be negotiated. The C-STORE sub-operations must be done on a different association to transfer images to the own Storage Service Class SCP.

The FLUOROSPOT Compact will make use of the “list of UID” mechanism when specifying the Instances to be retrieved.

The Move SCU interprets following status codes:

Service Status	Meaning	Error Codes	Related Fields
Refused	Out of Resources – Unable to calculate number of matches	A701	(0000,0902)
	Out of Resources – Unable to perform sub operations	A702	(0000,1020) (0000,1021) (0000,1022) (0000,1023)
Failed	Identifier does not match SOP Class	A900	(0000,0901) (0000,0902)
	Unable to process	CXXX	(0000,0901) (0000,0902)
Cancel	Sub-operations terminated due to Cancel Indication	FE00	(0000,1020) (0000,1021) (0000,1022) (0000,1023)
Warning	Sub-operations Complete – One or more Failures of Warnings	B000	(0000,1020) (0000,1021) (0000,1022) (0000,1023)

Service Status	Meaning	Error Codes	Related Fields
Success	Sub-operations Complete – No Failures or Warning	0000	(0000,1020) (0000,1021) (0000,1022) (0000,1023)
Pending	Sub-operations are continuing	FF00	(0000,1020) (0000,1021) (0000,1022) (0000,1023)

9.1.2.2.4 Associated Real-World Activity – Import from “Deleted Patients”

When selecting a data entry in the “Deleted Patients” UI and activate the “Import” function, a retrieval request is passed to the archival application which issues a C-MOVE service according to the Study Root query model. (The Storage Service Class Conformance Statement SCP section describes the response behavior to the C-STORE request sub-operation that is generated by the SCP when processing the C-MOVE request.). Instances can only be transferred to the system that originated the Import request.

The transferred image data are processed as described in the Storage Class SCP descriptions.

9.1.2.2.5 Proposed Presentation Contexts – Import from “Deleted Patients”

The FLUOROSPOT Compact DICOM application will propose Presentation Contexts as shown in the following table:

Presentation Context Table					
Abstract Syntax		Transfer Syntax		Role	Ext. Neg.
Name	UID	Name List	UID List		
Study Root Query/Retrieve Model – MOVE	1.2.840.10008.5.1.4.1.2.2.2	Implicit VR Little Endian Explicit VR Big Endian Explicit VR Little Endian	1.2.840.10008.1.2 1.2.840.10008.1.2.2 1.2.840.10008.1.2.1	SCU	None

9.1.2.2.6 SOP Specific Conformance Statement – Import from “Deleted Patients”

At association establishment time the C-MOVE presentation context shall be negotiated. The C-STORE sub-operations must be done on a different association to transfer images to the own Storage Service Class SCP.

The Move SCU interprets following status codes:

Service Status	Meaning	Error Codes	Related Fields
Refused	Out of Resources – Unable to calculate number of matches	A701	(0000,0902)
	Out of Resources – Unable to perform sub operations	A702	(0000,1020) (0000,1021) (0000,1022) (0000,1023)
Failed	Identifier does not match SOP Class	A900	(0000,0901) (0000,0902)
	Unable to process	CXXX	(0000,0901) (0000,0902)
Cancel	Sub-operations terminated due to Cancel Indication	FE00	(0000,1020) (0000,1021) (0000,1022) (0000,1023)
Warning	Sub-operations Complete – One or more Failures of Warnings	B000	(0000,1020) (0000,1021)

Service Status	Meaning	Error Codes	Related Fields
			(0000,1022) (0000,1023)
Success	Sub-operations Complete – No Failures or Warning	0000	(0000,1020) (0000,1021) (0000,1022) (0000,1023)
Pending	Sub-operations are continuing	FF00	(0000,1020) (0000,1021) (0000,1022) (0000,1023)

9.1.3 Association Acceptance Policy

Not applicable.

10 Implementation Model Modality Worklist

The Basic Worklist Management Service Class defines an application-level class-of-service that facilitates access to worklists. The worklist is queried by the AE (modality) and supplies the SCU with the tasks scheduled and which have to be performed on the modality. The FLUOROSPOT Compact DICOM application will support the Modality Worklist SOP class as SCU.

10.1 Application Data Flow Diagram

Worklist Update is performed as a result of an operator request. Each request results in an initiation for an association. Under normal condition the association will be closed after receiving a "Success" response from the Information System.

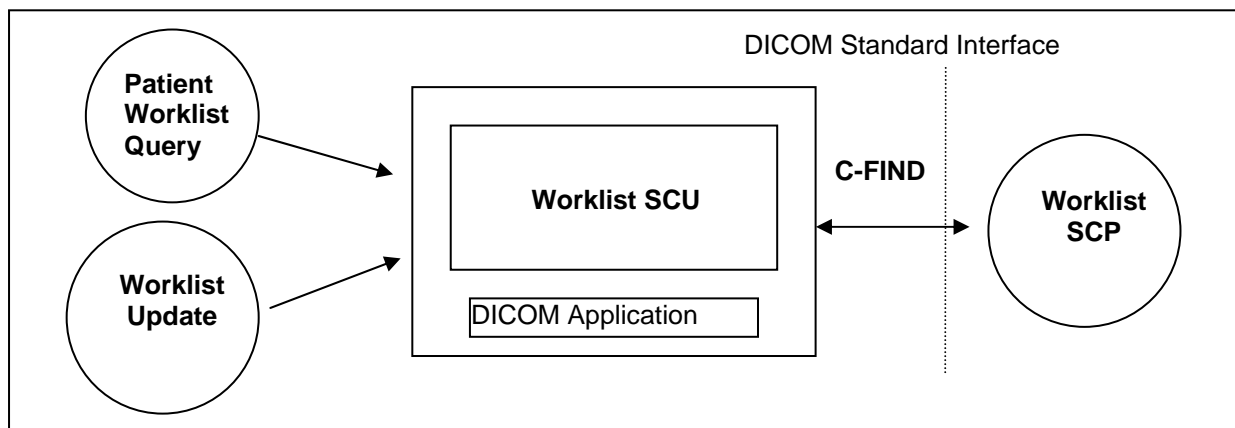

Figure 5: FLUOROSPOT Compact Application Data Flow Diagram – Modality Worklist

10.2 Functional Definitions of Application Entities

The request for a Worklist Update is initiated either by user interaction, i.e. pressing the button "Worklist Update" or automatically at configurable time intervals and at the switch from Patient Mode to Examination Mode. With "Worklist Update" the automated Query mechanism is performed immediately on request, while with "Patient Worklist Query" a dialog to enter search criteria is opened and an interactive query can be performed.

Upon initiation of the request, the FLUOROSPOT Compact will build an Identifier for the C-FIND request, will initiate an association to send the request and will wait for Worklist responses. After retrieval of all responses, FLUOROSPOT Compact will access the local database to add or update patient demographic data. To protect the system from overflow, the FLUOROSPOT Compact will limit the number of processed Worklist responses to a configurable maximum.

With automated worklist queries (including "Worklist Update") the FLUOROSPOT Compact always requests all items for a configured Scheduled Procedure Step Start Date, Modality Type and the Scheduled Station AE Title.

If any other SCP response status than "Success" or "Pending" is received by FLUOROSPOT Compact, a message "update failed" will appear on the user interface.

The FLUOROSPOT Compact Worklist Request Identifier is described in Annex A.10.

10.3 Sequencing of Real-World Activities

Not applicable.

11 AE Specification Modality Worklist

11.1 Modality Worklist Service AEs Specification

SIEMENS FLUOROSPOT Compact DICOM products provide Standard Conformance to the following DICOM SOP Classes as SCU:

SOP Class Name	SOP Class UID
Modality Worklist Information Model – FIND	1.2.840.10008.5.1.4.31

11.1.1 Association Establishment Policies

11.1.1.1 General

Worklist can be queried in automated mode – either cyclic or with “Update” – or with an interactive query with search criteria entered by application.

The default PDU size used will be 64 KB.

11.1.1.2 Number of Associations

The FLUOROSPOT Compact DICOM application initiates one association at a time for a Worklist request.

11.1.1.3 Asynchronous Nature

The FLUOROSPOT Compact DICOM software does not support asynchronous communication (multiple outstanding transactions over a single association).

11.1.1.4 Implementation Identifying Information

Implementation Class UID	1.3.12.2.1107.5.3.4
Implementation Version Name	Siemens_FLC_60

11.1.2 Association Initiation Policy

The FLUOROSPOT Compact DICOM Application Entity acts as a Service Class User (SCU) for the Modality Worklist Service Class (to request a Worklist from a RIS).

To do so, the FLUOROSPOT Compact will issue a

- C-FIND DIMSE according to the Modality Worklist Information Model or a
- C-FIND-CANCEL DIMSE to stop processing of running worklist query.

11.1.2.1 Real-World Activity

11.1.2.1.1 Associated Real-World Activity – Patient Worklist Query

Patient Worklist Query will display a dialog for entering data as search criteria. When the Query is started on user request, only the data from the dialog will be inserted as matching keys into the query. An association is established and the query is sent. During receiving the worklist response items are counted and the query processing is canceled if the configurable limit of items (maximum **999**) is reached. The results will be displayed in a separate list. All worklist data from previous queries will be deleted when new data is received.

11.1.2.1.2 Proposed Presentation Contexts – Patient Worklist Query

The FLUOROSPOT Compact DICOM application will propose Presentation Contexts as shown in the following table:

Presentation Context Table					
Abstract Syntax		Transfer Syntax		Role	Ext. Neg.
Name	UID	Name List	UID List		
Modality Worklist Information Model – FIND	1.2.840.10008.5.1.4.31	Implicit VR Little Endian Explicit VR Big Endian Explicit VR Little Endian	1.2.840.10008.1.2 1.2.840.10008.1.2.2 1.2.840.10008.1.2.1	SCU	None

11.1.2.1.3 SOP Specific Conformance Statement – Patient Worklist Query

Please refer to Annex A.10 for the description of the FLUOROSPOT Compact Worklist Request Identifier.

If any other SCP response status than “Success” or “Pending” is received by FLUOROSPOT Compact, a message “query failed” will appear on the user interface.

11.1.2.1.4 Associated Real-World Activity –Worklist Update

Worklist Update attempts to download a Worklist from a remote node. If the FLUOROSPOT Compact AE establishes an association to a remote AE, it will transfer all worklist items via the open association. Also here the incoming worklist response items are counted and the query processing is canceled if the configurable limit of items (maximum **999**) is reached. The results will be displayed in a separate list. All worklist data from previous queries will be deleted when new data is received.

11.1.2.1.5 Proposed Presentation Contexts –Worklist Update

The FLUOROSPOT Compact DICOM application will propose Presentation Contexts as shown in the following table:

Presentation Context Table					
Abstract Syntax		Transfer Syntax		Role	Ext. Neg.
Name	UID	Name List	UID List		
Modality Worklist Information Model – FIND	1.2.840.10008.5.1.4.31	Implicit VR Little Endian Explicit VR Big Endian Explicit VR Little Endian	1.2.840.10008.1.2 1.2.840.10008.1.2.2 1.2.840.10008.1.2.1	SCU	None

11.1.2.1.6 SOP Specific Conformance Statement –Worklist Update

Please refer to Annex A.10 for the description of the FLUOROSPOT Compact Worklist Request Identifier.

If any other SCP response status than “Success” or “Pending” is received by FLUOROSPOT Compact, a message “update failed” will appear on the user interface.

11.1.3 Association Acceptance Policy

Not applicable.

12 Implementation Model Modality Performed Procedure Step

The FLUOROSPOT Compact DICOM application will support the Modality Performed Procedure Step (MPPS) SOP class as SCU.

12.1 Application Data Flow Diagram

MPPS Update is performed as a result of an operator request. Applying dose through acquisition of images or fluoroscopy mode will result in automated creation on a MPPS Instance. Each request results in an initiation for an association. The association will be closed after receiving a "Success" response from the Information System.

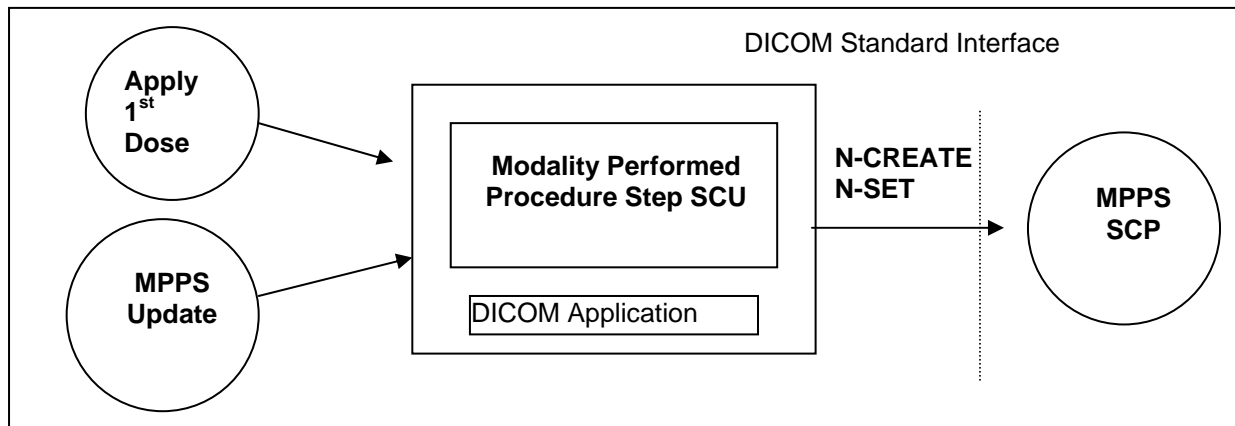

Figure 6: FLUOROSPOT Compact Application Data Flow Diagram – Modality Performed Procedure Step

12.2 Functional Definitions of Application Entities

With the 1st Dose applied consecutive to registering a Patient (Scheduled Procedure Step from Worklist), the FLUOROSPOT Compact DICOM application will create a MPPS Instance and communicate it to the MPPS SCP.

To inform the MPPS SCP about the progress or the completion of an MPPS instance, an update can be performed. It is configurable for the user how the update is performed:

- Automatic (status "COMPLETED" is sent after a patient gets inactive)
- Automatic with MPPS Dialog ("COMPLETED", "IN PROGRESS" or "DISCONTINUED" can be selected. Dialog is displayed after a patient gets inactive)
- Manual with MPPS Dialog ("COMPLETED", "IN PROGRESS" or "DISCONTINUED" can be selected.)

After a state of "COMPLETED" or "DISCONTINUED", the FLUOROSPOT Compact DICOM application will no longer allow updates on the related MPPS Instance.

The FLUOROSPOT Compact will support creation of "unscheduled cases" by allowing MPPS Instances to be communicated for locally registered Patients.

12.3 Sequencing of Real-World Activities

Not applicable.

13 AE Specification Modality Performed Procedure Step

13.1 Modality Performed Procedure Step Service AEs Specification

SIEMENS FLUOROSPOT Compact DICOM products provide Standard Conformance to the following DICOM SOP Classes as SCU:

SOP Class Name	SOP Class UID
Modality Performed Procedure Step	1.2.840.10008.3.1.2.3.3

13.1.1 Association Establishment Policies

13.1.1.1 General

The creation of a MPPS Instance is done automatically by FLUOROSPOT Compact after the first application of radiation ("1st dose applied"). For emergency patients (patient data incomplete) the creation will be delayed until completion of the procedure step.

If the 1st dose is applied, while a worklist update is in progress, the MPPS N-Create is delayed until the next update of the Procedure Step.

Further updates on the MPPS data can either be done interactively from the related MPPS user interface or will automatically performed if configured by the user.

The default PDU size used will be 64 KB.

13.1.1.2 Number of Associations

The FLUOROSPOT Compact DICOM application initiates one association at a time for a communication of MPPS information.

13.1.1.3 Asynchronous Nature

The FLUOROSPOT Compact DICOM software does not support asynchronous communication (multiple outstanding transactions over a single association).

13.1.1.4 Implementation Identifying Information

Implementation Class UID	1.3.12.2.1107.5.3.4
Implementation Version Name	Siemens_FLC_60

13.1.2 Association Initiation Policy

The FLUOROSPOT Compact DICOM Application Entity acts as a Service Class User (SCU) for the Modality Performed Procedure Step Service Class (to notify a RIS about status of a procedure while it is performed).

To do so, the FLUOROSPOT Compact will issue a

- N-CREATE DIMSE according to the CREATE Modality Performed Procedure Step SOP Instance operation or a
- N-SET DIMSE to update the contents and state of the MPPS according to the SET Modality Performed Procedure Step Information operation.

13.1.2.1 Real-World Activity

13.1.2.1.1 Associated Real-World Activity – Apply 1st Dose

Consecutive to registration of Patient, the FLUOROSPOT Compact is awaiting the 1st application of radiation to the patient (“1st dose applied”). For emergency patients (patient data incomplete) the creation will be delayed until completion of the procedure step. From this event the trigger to create a MPPS Instance is derived. The related Instance is then immediately communicated to the configured RIS system. An association is established and the MPPS Instance is sent.

13.1.2.1.2 Proposed Presentation Contexts – Apply 1st Dose

The FLUOROSPOT Compact DICOM application will propose Presentation Contexts as shown in the following table:

Presentation Context Table					
Abstract Syntax		Transfer Syntax		Role	Ext. Neg.
Name	UID	Name List	UID List		
Modality Performed Procedure Step	1.2.840.10008.3.1.2.3.3	Implicit VR Little Endian Explicit VR Big Endian Explicit VR Little Endian	1.2.840.10008.1.2 1.2.840.10008.1.2.2 1.2.840.10008.1.2.1	SCU	None

13.1.2.1.3 SOP Specific Conformance Statement – Apply 1st Dose

Please refer to Annex A.11 for the description of the FLUOROSPOT Compact Modality Performed Procedure Step CREATE Request Identifier.

13.1.2.1.4 Associated Real-World Activity – MPPS Update

With a dedicated MPPS UI it is possible to set additional information and set the state to finalize the MPPS. Sending updates of the MPPS Instance can be interactively triggered. A MPPS Instance that has been sent with a state of “COMPLETED” or “DISCONTINUED” can no longer be updated.

A MPPS state of “COMPLETED” can also be sent automatically after a patient gets inactive. This automatic update without any user input, is configurable for the user.

13.1.2.1.5 Proposed Presentation Contexts – MPPS Update

The FLUOROSPOT Compact DICOM application will propose Presentation Contexts as shown in the following table:

Presentation Context Table					
Abstract Syntax		Transfer Syntax		Role	Ext. Neg.
Name	UID	Name List	UID List		
Modality Performed Procedure Step	1.2.840.10008.3.1.2.3.3	Implicit VR Little Endian Explicit VR Big Endian Explicit VR Little Endian	1.2.840.10008.1.2 1.2.840.10008.1.2.2 1.2.840.10008.1.2.1	SCU	None

13.1.2.1.6 SOP Specific Conformance Statement – MPPS Update

Please refer to Annex A.11 for the description of the FLUOROSPOT Compact Modality Performed Procedure Step SET Information Request Identifier.

The MPPS Set SCU interprets the following additional status code:

Service Status	Meaning	Error Codes
Processing Failure	Performed Procedure Step Object may no longer be updated	A710

If any other SCP response status than “Success” or “Pending” is received by FLUOROSPOT Compact, a message “MPPS update failed” will appear on the user interface.

13.1.3 Association Acceptance Policy

Not applicable.

14 Implementation Model Print

The Print Management Service Classes define an application-level class of services that facilitate the printing of images on a hardcopy medium. The print management SCU and the print management SCP are peer DICOM print management application entities. The FLUOROSPOT Compact DICOM print application supports the print management DIMSE services to act as SCU.

14.1 Application Data Flow Diagram

The FLUOROSPOT Compact DICOM network implementation is a Windows XP application and acts as SCU for the print management network service.

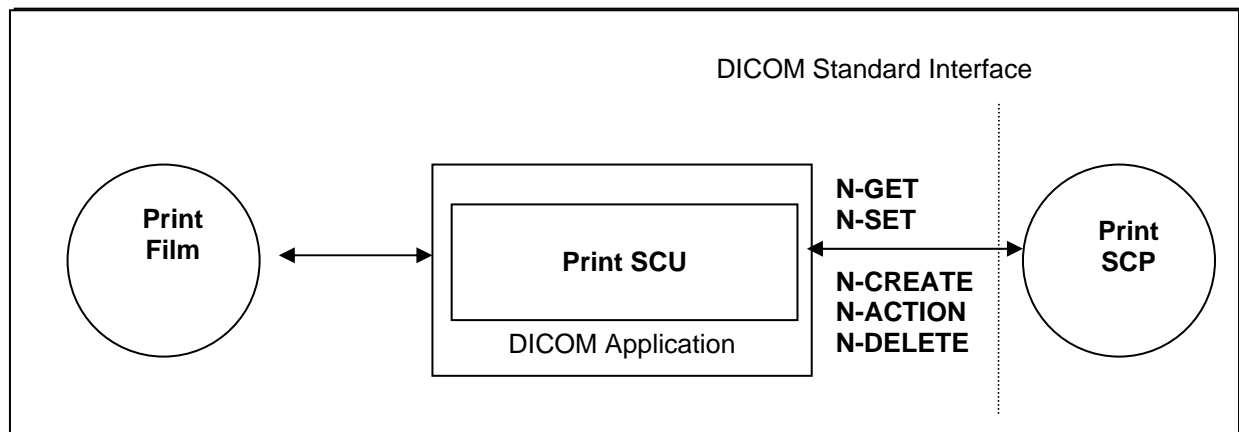

Figure 7: FLUOROSPOT Compact DICOM Application Data Flow Diagram – Print SCU

14.2 Functional Definition of Application Entities

The “Print Film” could either be invoked by the user interface whenever an image is ready to be printed on film, or automatically for a predefined set of images when study is completed.

The Print SCU will hold and maintain all data needed to compile a complete film-sheet from the data (images, layout, configuration) received. Whenever a film-sheet is ready to print, the related data is used to supply the information to the SOP Classes of the Basic Grayscale Print Management Meta SOP Class. A queue is maintained, in order to intermediately store up to 10 film-sheets in case of resource problems on printer. The SCU will only supply and require the mandatory SOP Classes of the Basic Grayscale Print Management Meta SOP Class.

It is configurable by the CSE to automatically initiate a retry for failed jobs.

14.3 Sequencing of Real-World Activities

Not applicable

15 Application Entity Specification Print

15.1 Print Management AE Specification

The FLUOROSPOT Compact print management SCU invokes print management DIMSE services to transfer images from the local AE to the remote SCP AE to print images with defined layout on a selected network-based DICOM hardcopy printer.

SIEMENS FLUOROSPOT Compact DICOM products provide Standard Conformance to the following DICOM Print Management Meta SOP Classes as SCU:

SOP Class Name	SOP Class UID
Basic Grayscale Print Management Meta SOP Class	1.2.840.10008.5.1.1.9

15.1.1 Association Establishment Policies

15.1.1.1 General

Whenever a film is completely set up, either automatically or by command, the job is prepared for processing. As soon as the queue is ready for processing the job, it is activated and encoded according the processing data. The related Print application will initiate an association to the print destination and process the printing of the related information.

The default PDU size used will be 64 KB.

15.1.1.2 Number of Associations

The FLUOROSPOT Compact DICOM application initiates one association at a time for each different print device configured.

15.1.1.3 Asynchronous Nature

The FLUOROSPOT Compact DICOM software does not support asynchronous communication (multiple outstanding transactions over a single association).

15.1.1.4 Implementation Identifying Information

Implementation Class UID	1.3.12.2.1107.5.3.4
Implementation Version Name	Siemens_FLC_60

15.1.2 Association Initiation Policy

Triggered by the Print job queue the Print Management SCU establishes an association by using the DICOM association services. With the help of the N-GET request for the Printer SOP Class the Status is determined before printing.

15.1.2.1 Associated Real-World Activity

15.1.2.1.1 Associated Real-World Activity – Print Film

Whenever a film-sheet is prepared by the user, it is forwarded to the Printer Job queue. As soon as the associated Printer device is available the job is activated and association is set up.

The film sheet is set up with the related Film Session and Film Box services. The images are internally processed and then sent as image boxes as needed. Status is controlled by awaiting any N-EVENT message all through the transfer until the last image or film-sheet is sent.

If the response from the remote application contains a status other than “Success” or “Warning” the association is aborted. It can be restarted any time by user interaction. An automatic retry can be configured by a CSE. The FLUOROSPOT Compact displays all warning and failure messages in the DICOM Film job list and writes them also into a log file.

15.1.2.1.2 Proposed Presentation Context – Print Film

The FLUOROSPOT Compact DICOM print application will propose Presentation Contexts as shown in the following table:

Presentation Context Table					
Abstract Syntax		Transfer Syntax		Role	Ext. Neg.
Name	UID	Name List	UID List		
Basic Grayscale Print Management Meta SOP class	1.2.840.10008.5.1.1.9	Implicit VR Little Endian	1.2.840.10008.1.2	SCU	None
		Explicit VR Little Endian	1.2.840.10008.1.2.1		
		Explicit VR Big Endian	1.2.840.10008.1.2.2		
Presentation LUT SOP class	1.2.840.10008.5.1.1.23	Implicit VR Little Endian	1.2.840.10008.1.2	SCU	None
		Explicit VR Little Endian	1.2.840.10008.1.2.1		
		Explicit VR Big Endian	1.2.840.10008.1.2.2		

15.1.2.1.3 SOP specific Conformance Statement – Meta SOP Classes

The FLUOROSPOT Compact DICOM print management SCU conforms to the DICOM Basic Grayscale Print Management Meta SOP Class.

The application uses a setting platform to define the properties of the connected DICOM Print SCP, e.g.:

- maximum number of print copies: **9**
- supported film sizes of the connected DICOM Print SCP
- supported film formats of the DICOM Print SCP

The printing is only suspended in the case of a failure return status of the Print SCP.

15.1.2.1.3.1 Basic Film Session SOP class

The Basic Film Session information object definition describes all the user-defined parameters that are common for all the films of a film session. The Basic Film Session refers to one or more Basic Film Boxes that are printed on one hardcopy printer.

The FLUOROSPOT Compact DICOM print management SCU supports the following DIMSE Service elements for the Basic Film Session SOP Class as SCU:

- N-CREATE
- N-DELETE

The Basic Film Session SOP Class N-CREATE-RQ (SCU) uses the following attributes:

Attribute Name	Tag	Usage SCU	Supported Values
Number of Copies	(2000,0010)	U	Set by user
Print Priority	(2000,0020)	U	MED

The affected SOP Instance UID received with N-CREATE-RSP message will be kept internally and used for later requests (e.g. N-DELETE-RQ) on the Basic Film Session – see below:

Attribute Name	Tag	Source of Information
Requested SOP Instance UID	(0000,1000) -> (0000,1001)	Affected SOP Instance UID of N-CREATE-RSP on Basic Film Session

The N-DELETE-RQ on the Basic Film Session SOP Class is used to remove the complete Basic Film Session SOP Instance hierarchy.

The Basic Film Session SOP class interprets the following status codes (from N-CREATE-RSP, N-DELETE-RSP messages):

Service Status	Meaning	Error Codes
Failed	Film session SOP instances hierarchy does not contain film box SOP instances	C600
	Unable to create print job, print queue is full	C601
	Image size is larger than images box size	C603
Warning	Memory allocation not supported	B600
	Film session printing is not supported	B601
	Film box does not contain image box (empty page)	B602
Success	Film box belonging to the film session is accepted for printing	0000

15.1.2.1.3.2 Basic Film Box SOP class

The Basic Film Box information object definition describes all the user-defined parameter of one film of the film session. The Basic Film Box information description defines the presentation parameters that are common for all images on a given sheet of film.

The Basic Film Box refers to one or more Image Boxes.

Supported Service Elements as SCU are:

- N-CREATE
- N-ACTION

The Basic Film Box SOP class N-CREATE-RQ message uses the following attributes (the actual values for each attribute depend on DICOM printer configuration within the FLUOROSPOT Compact DICOM print management SCU):

Attribute Name	Tag	Usage SCU	Supported Values
Image Display Format	(2010,0010)	M	(from Camera Configuration)
Referenced Film Session Sequence	(2010,0500)	M	
> Referenced SOP Class UID	(0008,1150)	M	1.2.840.10008.5.1.1.1
> Referenced SOP Instance UID	(0008,1155)	M	
Film Orientation	(2010,0040)	U	(from Camera Configuration) PORTRAIT or LANDSCAPE

Attribute Name	Tag	Usage SCU	Supported Values
Film Size ID	(2010,0050)	U	(from Camera Configuration) 8INX10IN, 10INX12IN, 11INX14IN,, 14INX14IN, 14INX17IN
Referenced Presentation LUT Sequence	(2050,0500)	MC	Only if Print Presentation LUT is configured for the DICOM Print SCP
> Referenced SOP Class UID	(0008,1150)	M	1.2.840.10008.5.1.1.23
> Referenced SOP Instance UID	(0008,1155)	M	Instance UID of presentation LUT object

The N-CREATE-RSP message from the Print SCP includes the Referenced Image Box Sequence with SOP Class/Instance UID pairs that will be kept internally to be further used for the subsequent Basic Image Box SOP Class N-SET-RQ messages.

When all Image Boxes (including parameters) for the film-sheet have been set, the FLUOROSPOT Compact DICOM print manager will issue a N-ACTION-RQ message with the SOP Instance UID of the Basic Film Box and the Action Type ID of 1.

The affected SOP Instance UID received with N-CREATE-RSP message will be kept internally and used for later requests (e.g. N-ACTION-RQ) on the Basic Film Box – see below:

Attribute Name	Tag	Source of Information
Requested SOP Instance UID	(0000,1000) -> (0000,1001)	Affected SOP Instance UID of N-CREATE-RSP on Basic Film Box

The Basic Film Box SOP class interprets the following status codes:

Service Status	Meaning	Error Codes
Failure	Unable to create print job, print queue is full	C601
	Image size is larger than images box size	C603
Warning	Film box does not contain image box (empty page)	B603
	Requested MinDensity or MaxDensity outside of Printer's operating range	B605
Success	Film accepted for printing	0000

15.1.2.1.3.3 Basic Grayscale Image Box SOP Class

The Basic Grayscale Image Box information object definition is the presentation of an image and image related data in the image area of a film. The Basic Image Box information describes the presentation parameters and image pixel data that apply to a single image of a sheet of film.

The Grayscale Image Box SOP Class uses only the N-SET-RQ with the following attributes:

Attribute Name	Tag	Usage SCU	Supported Values
Image Position	(2020,0010)	M	Depending on display format
Basic Grayscale Image Sequence	(2020,0110)	M	
> Samples per Pixel	(0028,0002)	M	1
> Photometric Interpretation	(0028,0004)	M	MONOCHROME2
> Rows	(0028,0010)	M	Equal for all images in one film session
> Columns	(0028,0011)	M	Equal for all images in one film session
> Pixel Aspect Ratio	(0028,0034)	M	1\1
> Bits Allocated	(0028,0100)	M	8
> Bits Stored	(0028,0101)	M	8
> High Bit	(0028,0102)	M	7

Attribute Name	Tag	Usage SCU	Supported Values
> Pixel Representation	(0028,0103)	M	0
> Pixel Data	(7FE0,0010)	M	
Requested Image Size	(2020,0030)	U	Only for RAD images

The Grayscale Image Box SOP class interprets the following status codes:

Service Status	Meaning	Error Codes
Failure	Image contains more pixel than printer can print in Image Box	C603
	Insufficient memory in printer to store the image	C605
Warning	Requested Min Density or Max Density outside of Printer's operating range	B605
Success		0000

15.1.2.1.3.4 Printer SOP Class

The Printer SOP Class is the possibility to monitor the status of the hardcopy printer in a synchronous and an asynchronous way.

The FLUOROSPOT Compact DICOM print manager can directly ask the Printer (SCP) for its status or receive events from the Printer asynchronously:

- N-GET as SCU
- N-EVENT-REPORT as SCU

In both cases the following information is supported:

Used Printer N-EVENT Report attributes

Event-type Name	Event	Attributes	Tag	Usage SCU
Normal	1			
Warning	2	Printer Status Info	(2110,0020)	U
Failure	3	Printer Status Info	(2110,0020)	U

Mandatory Printer N-GET-RSP, N-EVENT-REPORT-RQ attributes

Attribute Name	Tag	Usage SCP	Supported Values
Printer Status	(2110,0010)	M	NORMAL, FAILURE, WARNING
Printer Status Info	(2110,0020)	M	

15.1.2.1.4 SOP specific Conformance Statement - Print Presentation LUT SOP class

The objective of the Presentation LUT is to realize image hardcopy printing tailored for specific modalities, applications and user preferences.

The output of the Presentation LUT is Presentation Values (P-Values). P-Values are approximately related to human perceptual response. They are intended to facilitate common input for hardcopy. P-Values are intended to be independent of the specific class or characteristics of the hardcopy device.

The FLUOROSPOT Compact DICOM print management SCU supports the following DIMSE Service elements for the Print Presentation LUT SOP Class as SCU:

- N-CREATE
- N-DELETE

The Print Presentation LUT SOP Class N-CREATE-RQ (SCU) uses the following attributes:

Attribute Name	Tag	Usage SCU	Supported Values
Presentation LUT Shape	(2050,0020)	U	IDENTITY

15.1.3 Association Acceptance Policy

Not applicable

16 Communication Profiles

16.1 Supported Communication Stacks

The FLUOROSPOT Compact DICOM application provides DICOM TCP/IP Network Communication Support as defined in Part 8 of the DICOM Standard.

16.1.1 TCP/IP Stack

The FLUOROSPOT Compact DICOM application uses the TCP/IP stack from the Windows XP Operating System upon which it executes. It uses the MergeCOM-3 subroutine library from Merge Technologies Inc. that is based on a Berkeley socket interface.

16.1.1.1 API

The FLUOROSPOT Compact DICOM application uses the MergeCOM library that is based on a TCP/IP socket interface.

16.1.1.2 Physical Media Support

The FLUOROSPOT Compact DICOM application is indifferent to the physical medium over which TCP/IP executes; it inherits this from the Windows XP system upon which it executes.

17 Extensions / Specializations / Privatizations

17.1.1 Standard Extended / Specialized / Private SOPs

Please refer to Appendix A.1 and A.4 for all information on these topics. A detailed overview is given there.

17.1.2 Private Transfer Syntaxes

Not applicable

18 Configuration

18.1 AE Title/Presentation Address Mapping

To ensure unique identification within the network the hostname could be used as part of the AE Titles (see examples below, hostname = FLC1). The string can be up to 16 characters long and must not contain any extended characters, only 7-bit ASCII characters (excluding Control Characters) are allowed according to DICOM Standard.

18.1.1 DICOM Verification

The Verification Service uses the AE configuration of the DICOM Service that is checked with the C-ECHO message. E.g. Verification will use the Storage SCU AE, if initiated to check the configuration of a remote DICOM storage provider.

18.1.2 DICOM Storage SCP AE Title

The DICOM Storage Provider application provides an application entity title that can be configured via Service UI, this AE Title must be different from the Storage SCU AE Title:

e.g. FLC_STORE_SCP

The port number of the provider is set to the fixed value of

104

18.1.3 DICOM Storage SCU AE Title

The DICOM Storage User application provides an application entity title that can be configured via Service UI:

e.g. FLC_STORE_SCU

For each Storage destination the AET, Port and IP-Address can be configured.

18.1.4 DICOM Query/Retrieve AE Title

The DICOM Query/Retrieve application provides an own application entity title that can be configured via Service UI:

e.g. FLC_QR_SCU

For each Query/Retrieve provider the AET, Port and IP-Address can be configured.

18.1.5 DICOM Storage Commitment AE Title

The DICOM Storage Commitment application provides the application entity title that can be configured via Service UI:

e.g. FLC_STC_SCU

The port number is set to the fixed value of

104

For each Storage Commitment provider the AET, Port and IP-Address can be configured.

18.1.6 DICOM Worklist AE Title

The DICOM Worklist application provides an application entity title that can be configured via Service UI:

e.g. FLC_WK_SCU

For **one** Worklist provider the AET, Port and IP-Address can be configured.

18.1.7 DICOM MPPS AE Title

The DICOM Modality Performed Procedure Step application uses the same application entity title as configured for the DICOM Worklist application 18.1.6.

For **one** MPPS provider the AET, Port and IP-Address can be configured.

18.1.8 DICOM Print AE Title

The DICOM Print application provides the application entity title:

e.g. FLC_PRINT_SCU

The port number is set to the fixed value of

104

For each Print provider the AET, Port and IP-Address can be configured

18.2 Configurable Parameters

The Application Entity Titles, host names and port numbers are configured using the Siemens FLUOROSPOT Compact Service/Installation Tool. For each AET the list of services supported can be configured.

18.2.1 Storage and Query/Retrieve

The Siemens FLUOROSPOT Compact Service/Installation Tool can be used to set the AETs, port-numbers, host-names, IP-addresses and capabilities for the remote nodes (SCPs).

Storage:
(General Settings)

- Retry delay for failed jobs (range: 5 to 180 minutes, 0 means no retry). Maximum 5 retries will occur (per AE target).
- Usage of Pixel Spacing in addition to Imager Pixel Spacing
- **1 image per series** (default data model of FLUOROSPOT Compact) or **n images per series/Singleframe per series** (all single frame images, belonging to the same procedure step, are in the same series)
- Downscaling of Fluoroloops

(Node specific settings)

- Usage of Ready Window. Ready Window means, that windowing is calculated into the pixel data. Bit depth is not changed.
- IOD for XRF images: Secondary Capture or XRF
- Ready Processing (burn in of shutter, overlay, zoom and pan) for XRF IODs
- Archive flag
- Associated Storage Commitment Server

18.2.2 Storage Commitment

One destination (AET, Port and IP) can be configured for receiving Storage Commitment requests.

- A timeout (1-10s) for a Storage Commitment result within the same association can be defined.
- A Storage Commitment timeout and the number of retries could be configured in User Settings.

18.2.3 Modality Worklist

One destination (AET, Port and IP) can be configured for receiving Worklist requests.

- Time-out waiting for a response from the worklist provider (Query waiting time: maximum 999 s).
- Maximum of worklist entries received (Max. Query Match: maximum 999).
- Time between automated worklist queries (0 .. 1440 min.; 0 min means no automatic query) and used modality (0008,0060) in worklist query.
- Usage of own AET in worklist query (Query by AET)
- Time range used in worklist query

18.2.4 Modality Performed Procedure Step

One destination (AET, Port and IP) can be configured for receiving the MPPS data.

The "MPPS Complete" method can be selected in the user configuration.

18.2.5 Print

The Siemens FLUOROSPOT Compact Service/Installation Tool can be used to configure the SCPs (DICOM-Printers). The AET, host-name, IP-address and port-number can be set.

Print: Retry delay for failed jobs (range: 5 to 180 minutes, 0 means no retry). Maximum 5 retries will occur.

- Usage of Print Presentation LUT

18.3 Default Parameters

This installation tool also uses some default parameters:

- max. PDU size set to 65536 Bytes (64 KB)
- time-out for accepting/rejecting an association request: 60 s
- time-out for responding to an association open/close request: 60 s
- time-out for accepting a message over network: 60 s
- time-out for waiting for data between TCP/IP-packets: 60 s
- timeout for a network connect: 15s

The time-outs for waiting for a Service Request/Response message from the remote node are as follows:

- for Storage SCU: 30 s for single frame images, 600 s for multiframe
- for Storage SCP: 600 s
- for Query/Retrieve SCP/SCU: 600 s
- for Print Management SCU:
 - time-out for Response to N-SET-RQ: 25 s
 - time-out for Response to other Requests: 25 s

19 Support of Extended Character Sets

The Siemens FLUOROSPOT Compact DICOM application supports the

- ISO_IR 100 (ISO 8859-1:1987 Latin Alphabet No. 1 supplementary set)
- GB18030 (used when Chinese patient data input is configured)
- ISO 2022 IR 13, ISO 2022 IR 87 and ISO 2022 IR 159 (used when Japanese patient data input is configured)
- ISO_IR 144 (used when Russian patient data input is configured)

Application Profile Conformance Statement

This chapter contains the Conformance Statement to all “Offline Media Application Profiles (incl. private extensions)” supported by the FLUOROSPOT Compact archive options.

Those application profiles supported shall be:

- General Purpose CDR

1 Introduction

1.1 Purpose

This DICOM Conformance Statement describes the DICOM offline interface for Siemens X-ray acquisition modalities based on the FLUOROSPOT Compact imaging system according to part PS 3.2 of [DICOM].

1.2 Scope

The FLUOROSPOT Compact DICOM offline media storage service implementation acts as FSC, FSU and/or FSR for the specified application profiles and the related SOP Class instances.

1.3 Definitions, Terms and Abbreviations

ACR	American College of Radiology
AE	DICOM Application Entity
ASCII	American Standard Code for Information Interchange
CR	Computed Radiography
DCS	DICOM Conformance Statement
DICOM	Digital Imaging and Communications in Medicine
DIMSE	DICOM Message Service Element
DIMSE-C	DICOM Message Service Element with Composite information objects
FSC	File Set Creator
FSR	File Set Reader
FSU	File Set Updater
GSDF	Grayscale Standard Display Function
IOD	DICOM Information Object Definition
ISO	International Standard Organization
MOD	Magneto-optical Disk
NEMA	National Electrical Manufacturers Association
O	Optional Key Attribute
PDU	DICOM Protocol Data Unit
R	Required Key Attribute
RWA	Real-World Activity
U	Unique Key Attribute
XA	X-Ray Angiography
XRF	X-Ray Radiofluoroscopy

1.4 References

[DICOM] Digital Imaging and Communications in Medicine (DICOM), NEMA PS 3.1-18, 2009

1.5 Remarks

DICOM, by itself, does not guarantee interoperability. However, the Conformance Statement facilitates a first-level validation for interoperability between different applications supporting the same DICOM functionality as SCU and SCP, respectively.

This Conformance Statement is not intended to replace validation with other DICOM equipment to ensure proper exchange of information intended.

The scope of this Conformance Statement is to facilitate communication with Siemens and other vendors' Medical equipment. The Conformance Statement should be read and understood in conjunction with the DICOM Standard [DICOM]. It is, however, by itself not guaranteed to ensure the desired interoperability and a successful interconnectivity.

The user should be aware of the following important issues:

- The comparison of different conformance statements is the first step towards assessing interconnectivity between Siemens and non-Siemens equipment.
- Test procedures should be defined and tests should be performed by the user to validate the connectivity desired. DICOM itself and the conformance parts do not specify this.
- The standard will evolve to meet the users' future requirements. Siemens is actively involved in developing the standard further and therefore reserves the right to make changes to its products or to discontinue its delivery.
- Siemens reserves the right to modify the design and specifications contained herein without prior notice. Please contact your local Siemens representative for the most recent product information.

2 Implementation Model

2.1 Application Data Flow Diagram

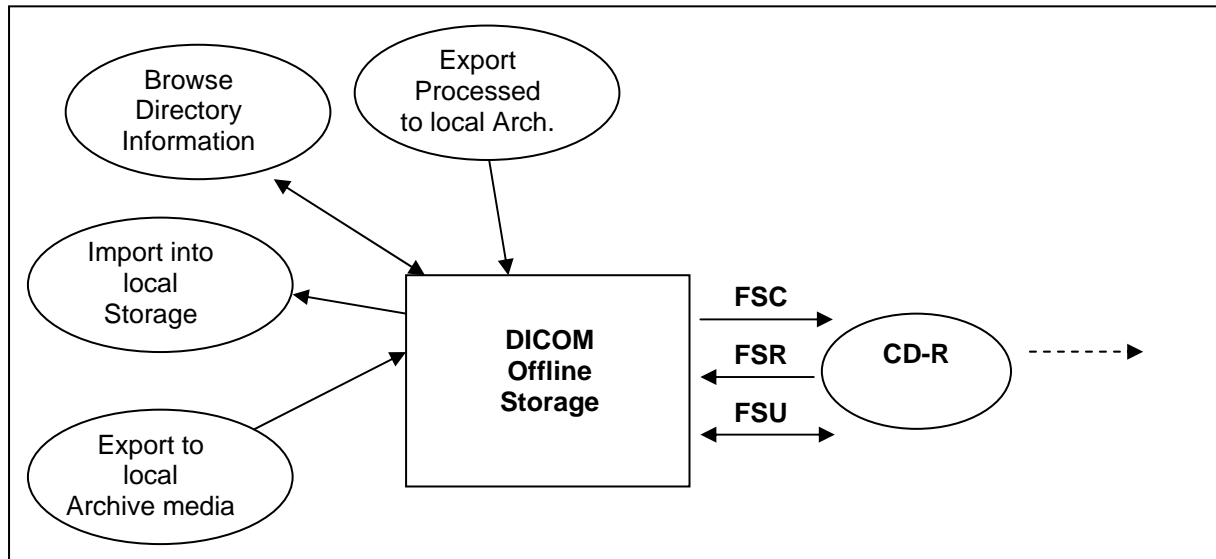

Figure 1: FLUOROSPOT Compact DICOM Media Storage Implementation Model

The DICOM Offline Storage application will serve as an interface to the CD-R offline medium device. It serves interfaces to include the offline media directory into the browser and to copy SOP instances to a medium or retrieve SOP Instances from medium into local storage.

The DICOM Offline Storage application will support the 120mm CD-R medium and the 120mm DVD-RAM medium.

The FSU role will update new SOP Instances only to media with pre-existing File-sets conforming to the Application Profiles supported.

The contents of the DICOMDIR will be temporarily stored in a local Archive-Database.

2.2 Functional Definitions of AEs

The FLUOROSPOT Compact DICOM offline media storage application consists of the DICOM application entity serving all interfaces to access offline media. The DICOM Offline Storage application is capable of

1. creating a new File-set onto an unwritten medium (Export to...).
2. updating an existing File-set by writing new SOP Instances onto the medium (Export to...).
3. importing SOP Instances from the medium onto local storage
4. reading the File-sets DICOMDIR information into temporary database and pass it to display applications.
5. Writing/Updating File-Sets with processed image export.

2.3 Sequencing of Real-World Activities

Not applicable.

2.4 File Meta Information Options

Implementation Class UID	1.3.12.2.1107.5.3.4
Implementation Version Name	Siemens_FLC_60

3 AE Specifications

3.1 DICOM Archive Specification

The DICOM Offline Storage provides Standard conformance to Media Storage Service Class (Interchange Option). Details are listed in following Table:

Application Profiles Supported	Real-World Activity	Role	SC Option
STD-GEN-CD	Browse Directory Information	FSR	Interchange
	Import into local Storage	FSR	Interchange
	Export to local Archive Media	FSC, FSU	Interchange

3.1.1 File Meta Information for the Application Entity

The Source Application Entity Title is set by configuration. See Chapter "Configuration" for details.

3.1.2 Real-World Activities for this Application Entity

3.1.2.1 Real-World Activity: Browse Directory Information

The DICOM Offline Storage application acts as FSR using the interchange option when requested to read the media directory.

The DICOM Offline Storage application will read the DICOMDIR and insert those directory entries, that are valid for the application profiles supported, into a local database. The database can then be used for browsing media contents.

During operation no "Attribute Value Precedence" is applied to the SOP Instances. Detached Patient Management is not supported.

3.1.2.1.1 Application Profiles for the RWA: Browse Directory Information

See Table in section 3.1 for the Application Profiles listed that invoke this Application Entity for the Browse Directory Information RWA.

3.1.2.2 Real-World Activity: Import into local Storage

The DICOM Offline Storage application acts as FSR using the interchange option when requested to read SOP Instances from the medium into the local storage.

The SOP Instance selected from the media directory will be copied into the local storage. Only SOP Instances, that are valid for the application profile supported, can be retrieved from media storage. This is due to the fact that the Browse Directory Information will filter all SOP Instances not matching the Application profiles supported.

During operation no "Attribute Value Precedence" is applied to the SOP Instances. Detached Patient Management is not supported.

The DICOM Offline Storage application supports only SOP Instances generated by the **FLUOROSPOT Compact** application.

For media conforming to the STD-GEN-CD Profile the following SOP classes will be supported as an FSR:

Information Object Definition	SOP Class UID	Transfer Syntax UID
Secondary Capture Image Storage	1.2.840.10008.5.1.4.1.1.7	Explicit VR Little Endian 1.2.840.10008.1.2.1
X-Ray Radiation Dose SR	1.2.840.10008.5.1.4.1.1.88.67	Explicit VR Little Endian 1.2.840.10008.1.2.1
X-Ray Radiofluoroscopic Image Storage (only for Fluorosystems)	1.2.840.10008.5.1.4.1.1.12.2	Explicit VR Little Endian 1.2.840.10008.1.2.1
Computed Radiography Image Storage (only for Radsystems)	1.2.840.10008.5.1.4.1.1.1	Explicit VR Little Endian 1.2.840.10008.1.2.1
Multi-frame True Color Secondary Capture Image Storage (only for UROSKOP Omnia)	1.2.840.10008.5.1.4.1.1.7.4	Explicit VR Little Endian 1.2.840.10008.1.2.1

3.1.2.2.1 Application Profiles for the RWA: Import into local Storage

See Table in section 3.1 for the Application Profiles listed that invoke this Application Entity for the Import into Local Storage RWA.

3.1.2.3 Real-World Activity: Export to local Archive Media

The DICOM Offline Storage application acts as FSU (for media with existing DICOM file-set) or FSC (media not initialized) using the interchange option when requested to copy SOP Instances from the local storage to local Archive Medium.

The DICOM Archive application will receive a list of marked SOP Instances to be copied to the local archive medium. According to the state of the medium inserted (new medium, Medium with DICOM file-set) the validity of the SOP Instances according to the applicable profile is checked. Only valid SOP Instances are accepted. The user can select if "all" images are marked or the marks from image acquisition will be retained.

The user can choose the IOD format of the instances: XRF or SC (Secondary Capture). RAD images are always stored in CR IOD. For XRF it can be configured to store images "ready processed".

The DICOM archive application will not close the medium.

Conforming to the STD-GEN-CD Profile the following SOP classes will be supported as an FSC and FSU:

Information Object Definition	SOP Class UID	Transfer Syntax UID
Secondary Capture Image Storage	1.2.840.10008.5.1.4.1.1.7	Explicit VR Little Endian 1.2.840.10008.1.2.1
X-Ray Radiation Dose SR	1.2.840.10008.5.1.4.1.1.88.67	Explicit VR Little Endian 1.2.840.10008.1.2.1

Information Object Definition	SOP Class UID	Transfer Syntax UID
X-Ray Radiofluoroscopic Image Storage (only for Fluorosystems)	1.2.840.10008.5.1.4.1.1.12.2	Explicit VR Little Endian 1.2.840.10008.1.2.1
Computed Radiography Image Storage (only for Radsystems)	1.2.840.10008.5.1.4.1.1.1	Explicit VR Little Endian 1.2.840.10008.1.2.1
Multi-frame True Color Secondary Capture Image Storage (only for UROSKOP Omnia)	1.2.840.10008.5.1.4.1.1.7.4	Explicit VR Little Endian 1.2.840.10008.1.2.1

3.1.2.3.1 Application Profiles for the RWA: Export to local Archive Media

See Table in section 3.1 for the Application Profiles listed that invoke this Application Entity for the Export to local Archive Media RWA.

4 Augmented and Private Profiles

4.1 Augmented Application Profiles

Not applicable.

4.2 Private Application Profiles

Not applicable.

5 Extensions, Specializations and Privatizations of SOP Classes and Transfer Syntaxes

The SOP Classes listed refer in majority to those created by the equipment to which this Conformance Statement is related to. For SOP classes not listed in this section, please refer to the Storage section of the DICOM Conformance Statement of the product. This will include all SOP Instances that can be received and displayed and therefore will be included into offline media storage even though these SOP Instances are not created by the equipment serving the Media Storage Service.

Restrictions and Extensions:

1. The DICOM Offline Storage application supports only SOP Instances generated by the **FLUOROSPOT Compact** application.
2. It is possible to store images on CD in a "packed" manner. This will result in a DICOMDIR containing "PRIVATE" records instead of "IMAGE" records. This functionality is not intended as exchange media with other systems.
3. The user can choose the IOD format of the instances: XRF or SC (Secondary Capture). RAD images are always stored in CR IOD. For XRF it can be configured to store images "ready processed".
4. It is possible to update a CD containing unpacked images with packed images and vice versa.

5.1 SOP Specific Conformance Statement for Basic Directory

5.1.1 Extension, Specialization for “Packed CD”

The PRIVATE directory records will be identified according to the information in the following table:

Attribute	Tag	Value used
Private Record UID	(0004,1432)	1.3.12.2.1107.5.3.4.1

5.1.2 DICOMDIR Attributes

The DICOMDIR file will contain the following attributes for the levels Patient – Study – Series – Image –Private

Attribute Name	Tag	Type	Notes
File Set Identification			
File-set ID	(0004,1130)	2	Volume label of media
Directory Information			
Offset of the First Directory Record of the Root Directory Entry	(0004,1200)	1	
Offset of the Last Directory Record of the Root Directory Entry	(0004,1202)	1	
File-set Consistency Flag	(0004,1212)	1	0000h
Directory Record Sequence	(0004,1220)	2	
> Offset of Next Directory Record	(0004,1400)	1C	
> Record In-use Flag	(0004,1410)	1C	FFFFh
> Offset of Referenced Lower-Level Directory Entity	(0004,1420)	1C	
> Directory Record Type	(0004,1430)	1C	PATIENT, STUDY, SERIES, IMAGE, PRIVATE
> Private Record UID	(0004,1432)	1C	For PRIVATE Directory Record
> Referenced File ID	(0004,1500)	1C	Filename and path, only for IMAGE Directory Records
> Referenced SOP Class UID in File	(0004,1510)	1C	For IMAGE Directory Records
> Referenced SOP Instance UID in File	(0004,1511)	1C	For IMAGE Directory Records
> Referenced Transfer Syntax UID in File	(0004,1512)	1C	For IMAGE Directory Records
> Record Selection Keys	See below	n. a.	
Patient Keys			Directory Record Type PATIENT
Specific Character Set	(0008,0005)	1C	
Patient's Name	(0010,0010)	2	
Patient ID	(0010,0020)	1	
Date of Birth	(0010,0030)	3	
Patient's Sex	(0010,0040)	3	
Study Keys			Directory Record Type STUDY
Specific Character Set	(0008,0005)	1C	
Study Date	(0008,0020)	1	
Study Time	(0008,0030)	1	
Accession Number	(0008,0050)	2	
Study Description	(0008,1030)	2	
Study Instance UID	(0020,000D)	1C	
Study ID	(0020,0010)	1	
Series Keys			Directory Record Type SERIES
Specific Character Set	(0008,0005)	1C	

Attribute Name	Tag	Type	Notes
Series Date	(0008,0021)	3	
Series Time	(0008,0031)	3	
Modality	(0008,0060)	1	
Institution Name	(0008,0080)	3	
Institution Address	(0008,0081)	3	Zero length
Series Description	(0008,103E)	3	
Performing Physician	(0008,1050)	3	
Series Instance UID	(0020,000E)	1	
Series Number	(0020,0011)	1	
Image Keys			Directory Record Type IMAGE
Image Type	(0008,0008)		
Instance Number	(0020,0013)	1	
Number of Frames	(0028,0008)	3	
Icon Image Sequence	(0088,0200)	3	
>Samples per Pixel	(0028,0002)	1C	1
>Photometric Interpretation	(0028,0004)	1C	MONOCHROME2
>Rows	(0028,0010)	1C	128
>Columns	(0028,0011)	1C	128
>Bits Allocated	(0028,0100)	1C	8
>Bits Stored	(0028,0101)	1C	8
>High Bit	(0028,0102)	1C	7
>Pixel Representation	(0028,0103)	1C	0000H
>Pixel Data	(7FE0,0010)	1C	Icon Image
Private Keys			Directory Record Type PRIVATE
Private Record UID	(0004,1432)	1	
Instance Number	(0020,0013)	1	

6 Configuration**6.1 AE Title Mapping****6.1.1 DICOM Media Storage AE Title**

The DICOM Storage application provides the application entity title:

Not applicable.

7 Support of Extended Character Sets

The Siemens **FLUOROSPOT Compact** DICOM application supports the

- ISO_IR 100 (ISO 8859-1:1987 Latin Alphabet No. 1 supplementary set)
- ISO_IR 144 (Cyrillic, supplementary set of ISO 8859, used when Russian patient data input is configured)
- GB18030 (used when Chinese patient data input is configured)
- ISO 2022 IR 13, ISO 2022 IR 87 and ISO 2022 IR 159 (used when Japanese patient data input is configured)

A APPENDIX

A.1 Common attributes in image and structured report IODs

“overview of supplied attributes – all type of images and structured report”

Attribute Name	Tag	Value
Specific Character Set	(0008,0005)	dependent on system configuration
Image Type	(0008,0008)	see A.8
SOP Class UID	(0008,0016)	1.2.840.10008.5.1.4.1.1.7
SOP Instance UID	(0008,0018)	System generated
Study Date	(0008,0020)	<yyyymmdd>
Series Date	(0008,0021)	<yyyymmdd>
Acquisition Date	(0008,0022)	<yyyymmdd>
Content Date	(0008,0023)	<yyyymmdd>
Study Time	(0008,0030)	<hhmmss>
Series Time	(0008,0031)	<hhmmss>
Acquisition Time	(0008,0032)	<hhmmss>
Image Time	(0008,0033)	<hhmmss>
Accession Number	(0008,0050)	From Modality Worklist or user input
Manufacturer	(0008,0070)	SIEMENS
Institution Name	(0008,0080)	From Configuration or value from Worklist
Referring Physician's Name	(0008,0090)	From Modality Worklist or user input
Station Name	(0008,1010)	From Configuration (hostname)
Study Description	(0008,1030)	Requested Procedure Description (0032,1060) from Modality Worklist or first Exam Name of the study
Procedure Code Sequence	(0008,1032)	(0032,1064) from Modality Worklist
> Code Value	(0008,0100)	(0032,1064) from Modality Worklist
> Coding Scheme Designator	(0008,0102)	(0032,1064) from Modality Worklist
> Coding Scheme Version	(0008,0103)	(0032,1064) from Modality Worklist
> Code Meaning	(0008,0104)	(0032,1064) from Modality Worklist
Series Description	(0008,103E)	Organ program name
Institutional Department Name	(0008,1040)	
Performing Physician's Name	(0008,1050)	Physician field in Study list, default (0040,0006) from Modality Worklist or user input
Operator's Name	(0008,1070)	User input
Admitting Diagnoses Description	(0008,1080)	From Modality Worklist or user input
Manufacturer's Model Name	(0008,1090)	"Fluorospot Compact FD" for detector systems "Fluorospot Compact" for Image Intensifier systems
Referenced Study Sequence	(0008,1110)	From Modality Worklist
> Referenced SOP Class UID	(0008,1150)	From Modality Worklist
> Referenced SOP Instance UID	(0008,1155)	From Modality Worklist
Referenced Patient Sequence	(0008,1120)	From Modality Worklist
> Referenced SOP Class UID	(0008,1150)	From Modality Worklist
> Referenced SOP Instance UID	(0008,1155)	From Modality Worklist
Referenced Performed Procedure Step Sequence	(0008,1111)	Only with MPPS
> Referenced SOP Class UID	(0008,1150)	1.2.840.10008.3.1.2.3.3 (MPPS)
> Referenced SOP Instance UID	(0008,1155)	Reference to MPPS
Derivation Description	(0008,2111)	
Patient's Name	(0010,0010)	From Modality Worklist or user input (all 5 components)
Patient ID	(0010,0020)	From Modality Worklist or user input
Patient's Birth Date	(0010,0030)	From Modality Worklist or user input
Patient's Sex	(0010,0040)	From Modality Worklist or user input
Other Patient IDs	(0010,1000)	From Modality Worklist

Attribute Name	Tag	Value
Other Patient Names	(0010,1001)	From Modality Worklist
Patient's Age	(0010,1010)	
Patient's Size	(0010,1020)	From Modality Worklist or user input
Patient's Weight	(0010,1030)	From Modality Worklist or user input
Ethnic Group	(0010,2160)	From Modality Worklist
Additional Patient History	(0010,21B0)	From Modality Worklist
Patient Comments	(0010,4000)	From Modality Worklist
Body Part Examined	(0018,0015)	-value from OGP -Zero length if not available
Device Serial Number	(0018,1000)	From Configuration
Software Version	(0018,1020)	From Configuration
Protocol Name	(0018,1030)	Organ program name
Date of Last Calibration	(0018,1200)	
Study Instance UID	(0020,000D)	From Modality Worklist or generated by FLC
Series Instance UID	(0020,000E)	System generated
Study ID	(0020,0010)	User Input, default (0040,1001) from Modality Worklist
Series Number	(0020,0011)	System generated
Acquisition Number	(0020,0012)	System generated
Instance Number	(0020,0013)	System generated
Patient Orientation	(0020,0020)	not available
Laterality	(0020,0060)	Zero length if not available, not sent when Laterality is "both" or "unpaired"
Image Comments	(0020,4000)	From user input
Burned in Annotations	(0028,0301)	"NO"
Window Center	(0028,1050)	0..4095
Window Width	(0028,1051)	1...4095
Lossy Image Compression	(0028,2110)	"00"
Study Comments	(0032,4000)	User Input
Current Patient Location	(0038,0300)	From Modality Worklist
Performed Procedure Step Start Date	(0040,0244)	= (0008,0020)
Performed Procedure Step Start Time	(0040,0245)	= (0008,0030)
Performed Procedure Step ID	(0040,0253)	
Performed Procedure Step Description	(0040,0254)	= (0008,1030)
Performed Protocol Code Sequence	(0040,0260)	Only present, if usage of protocol codes is configured in user settings
> Code Value	(0008,0100)	
> Coding Scheme Designator	(0008,0102)	
> Coding Scheme Version	(0008,0103)	
> Code Meaning	(0008,0104)	
Request Attributes Sequence	(0040,0275)	
>Scheduled Procedure Step Description	(0040,0007)	From Modality Worklist
> Scheduled Protocol Code Sequence	(0040,0008)	From Modality Worklist
>> Code Value	(0008,0100)	From Modality Worklist
>> Coding Scheme Designator	(0008,0102)	From Modality Worklist
>> Coding Scheme Version	(0008,0103)	From Modality Worklist
>> Code Meaning	(0008,0104)	From Modality Worklist
>Scheduled Procedure Step ID	(0040,0009)	From Modality Worklist
>Requested Procedure ID	(0040,1001)	From Modality Worklist or user input
Presentation LUT Shape	(2050,0020)	"IDENTITY"
Pixel Data	(7FE0,0010)	System generated

A.2 SC Standard Extended SOP Class

“overview of specific attributes – SC image”

Attribute Name	Tag	Value
Modality	(0008,0060)	RF
Conversion Type	(0008,0064)	DI
Body Part Examined	(0018,0015)	-value from OGP -Zero length if not available
Samples per Pixel	(0028,0002)	
Photometric Interpretation	(0028,0004)	
Rows	(0028,0010)	
Columns	(0028,0011)	
Bits Allocated	(0028,0100)	
Bits Stored	(0028,0101)	
High Bit	(0028,0102)	
Pixel Representation	(0028,0103)	

A.3 Multiframe True Color SC Storage Standard Extended SOP Class

“overview of specific attributes – Multiframe True Color SC image”

Attribute Name	Tag	Value
Modality	(0008,0060)	OT
Conversion Type	(0008,0064)	WSD
Series Description	(0008,103E)	not present
Derivation Description	(0008,2111)	not present
Body Part Examined	(0018,0015)	
Protocol Name	(0018,1030)	not present
Samples per Pixel	(0028,0002)	3
Photometric Interpretation	(0028,0004)	RGB
Planar Configuration	(0028,0006)	0
Number of Frames	(0028,0008)	1 for CAP images >=1 for Medical Report
Frame Increment Pointer	(0028,0009)	(0018,1063)
Rows	(0028,0010)	
Columns	(0028,0011)	
Bits Allocated	(0028,0100)	8
Bits Stored	(0028,0101)	8
High Bit	(0028,0102)	7
Pixel Representation	(0028,0103)	0000H
Pixel Intensity Relationship	(0028,1040)	“LIN”
Window Center	(0028,1050)	not present
Window Width	(0028,1051)	not present

A.4 XRF Standard Extended SOP Class

A.4.1 configuration "XRF – Full"

"overview of specific attributes – XRF image(full)"

Attribute Name	Tag	Value
Modality	(0008,0060)	"RF"
Recommended Display Frame Rate	(0008,2144)	Only for multi-frame
Body Part Examined	(0018,0015)	-value from OGP -Zero length if not available
KVP	(0018,0060)	From Acquisition
Device Serial Number	(0018,1000)	From Configuration
Frame Time	(0018,1063)	Only if multi-frame
Distance Source to Detector	(0018,1110)	SID from Acquisition
Distance Source to Patient	(0018,1111)	SOD (only if table object distance, image receptor table distance and SID are available)
Estimated Radiographic Magnification Factor	(0018,1114)	only if SID and SOD are available (=SID/SOD)
Table Motion	(0018,1134)	"STATIC"
Table Angle	(0018,1138)	From Acquisition
Table Type	(0018,113A)	"TILTING"
Field of View Shape	(0018,1147)	"RECTANGLE"
Field of View Dimension(s)	(0018, 1149)	rows\columns in mm not for store from fluoro
Exposure Time	(0018,1150)	Cumulative time: pulse width * number of frames
Exposure	(0018,1152)	
Exposure in μ As	(0018,1153)	
X-Ray Tube Current	(0018,1151)	From Acquisition, in mA
Filter Type	(0018,1160)	Defined Terms: "NONE", "CU_0.1_MM", "CU_0.2_MM", "CU_0.3_MM"
Average Pulse Width	(0018,1154)	From Acquisition
Radiation Setting	(0018,1155)	GR or SC
Radiation Mode	(0018,115A)	PULSED
Image Area Dose Product	(0018,115E)	If dose measurement is available, in dGy cm ²
Imager Pixel Spacing	(0018,1164)	For detector images: "0.148\0.148" or "0.296\0.296" or "0.444\0.444" For I.I: images: zoomed image size/1024
Grid	(0018,1166)	"NONE", "FOCUSED", "UNIVERSAL"
Date of Last Calibration	(0018,1200)	
Acquisition Device Processing Description	(0018,1400)	Description of processing parameter set
Acquisition Device Processing Code	(0018,1401)	Code to identify processing parameter set
Relative X-Ray Exposure	(0018,1405)	Exposure Index (EXI)
Column Angulation	(0018,1450)	From Acquisition
Tomo Layer Height	(0018,1460)	only for tomo acquisitions
Tomo Angle	(0018,1470)	only for tomo acquisitions
Tomo Time	(0018,1480)	only for tomo acquisitions
Positioner Type	(0018,1508)	
Shutter Shape	(0018,1600)	RECTANGULAR for detector images CIRCULAR for I.I images
Shutter Left Vertical Edge	(0018,1602)	From Acquisition / Post-processing
Shutter Right Vertical Edge	(0018,1604)	From Acquisition / Post-processing
Shutter Upper Horizontal Edge	(0018,1606)	From Acquisition / Post-processing
Shutter Lower Horizontal Edge	(0018,1608)	From Acquisition / Post-processing
Center of Circular Shutter	(0018,1610)	for I.I images
Radius of Circular Shutter	(0018,1612)	for I.I images
View Position	(0018,5101)	Only if information is available
Sensitivity	(0018,6000)	

Attribute Name	Tag	Value
Detector Conditions Nominal Flag	(0018,7000)	Set to "NO" if user was notified about possible image quality compromise, e.g. because detector temperature is out of range
Detector Temperature	(0018,7001)	the last received detector temperature is used
Detector Type	(0018,7004)	"SCINTILLATOR"
Detector Description	(0018,7006)	only for detector images Detector data: - Factory Serial Number - Factory Date Code - Configuration Version - Factory Part Number
Detector ID	(0018,700A)	Factory Serial Number
Date of Last Detector Calibration	(0018,700C)	
Time of Last Detector Calibration	(0018,700E)	
Field of View Origin	(0018,7030)	
Field of View Rotation	(0018,7032)	Enumerated Values: "0", "90", "180", "270"
Field of View Horizontal Flip	(0018,7034)	Enumerated Values: "NO", "YES"
Grid Focal Distance	(0018,704C)	"1150", "1250", "1500", "1800", "3000" only if Grid (0018,1166) = FOCUSED"
X-Ray Tube Current in μ A	(0018,8151)	
Samples per Pixel	(0028,0002)	
Photometric Interpretation	(0028,0004)	
Number of Frames	(0028,0008)	Only if multi-frame
Frame Increment Pointer	(0028,0009)	<0018,1063> only if multi-frame
Rows	(0028,0010)	
Columns	(0028,0011)	
Pixel Spacing	(0028,0030)	only if configured in service value = 0018,1164 if no SOD is present otherwise: value = (0018,1164) * SOD / SID
Bits Allocated	(0028,0100)	
Bits Stored	(0028,0101)	
High Bit	(0028,0102)	
Pixel Representation	(0028,0103)	
Pixel Intensity Relationship	(0028,1040)	LIN or LOG
Recommended Viewing Mode	(0028,1090)	NAT, SUB, only if multi-frame and (0028,1040) = LOG
Window Center & Width Explanation	(0028,1055)	only if (0028,1040) = LOG
Modality LUT Sequence	(0028,3000)	always if (0028,1040) = LOG otherwise only if configured
> LUT Descriptor	(0028,3002)	
> Modality LUT Type	(0028,3004)	
> LUT Data	(0028,3006)	
Representative Frame Number	(0028,6010)	Only if multi-frame
Mask Subtraction Sequence	(0028,6100)	Only if multi-frame and (0028,1040) = LOG
> Mask Operation	(0028,6101)	"AVG_SUB"
> Mask Frame Numbers	(0028,6110)	Mask Frame Number (always only one mask)
> Mask Sub-pixel Shift	(0028,6114)	From Post-processing
Overlay Rows	(6000,0010)	Same as (0028,0010)
Overlay Columns	(6000,0011)	Same as (0028,0011)
Number of Frames in Overlay	(6000,0015)	only if multi-frame, same as (0028,0008)
Overlay Type	(6000,0040)	"G"
Overlay Origin	(6000,0050)	1\1
Image Frame Origin	(6000,0051)	only if multi-frame, 1
Overlay Bits Allocated	(6000,0100)	16 or 1
Overlay Bit Position	(6000,0102)	12 or 0
Overlay Data	(6000,3000)	only if 0028,0100 = 1

A.4.2 configuration “XRF – Ready Processed”

“overview of specific attributes – XRF image (ready processed)”

Attribute Name	Tag	Value
Modality	(0008,0060)	“RF”
Recommended Display Frame Rate	(0008,2144)	Only for multi-frame
Body Part Examined	(0018,0015)	-value from OGP -Zero length if not available
KVP	(0018,0060)	From Acquisition
Device Serial Number	(0018,1000)	From Configuration
Frame Time	(0018,1063)	Only if multi-frame
Distance Source to Detector	(0018,1110)	SID from Acquisition
Distance Source to Patient	(0018,1111)	SOD (only if table object distance, image receptor table distance and SID are available)
Estimated Radiographic Magnification Factor	(0018,1114)	only if SID and SOD are available (=SID/SOD)
Table Motion	(0018,1134)	“STATIC”
Table Angle	(0018,1138)	From Acquisition
Table Type	(0018,113A)	“TILTING”
Field of View Shape	(0018,1147)	“RECTANGLE”
Field of View Dimension(s)	(0018, 1149)	rows\columns in mm not for store from fluoro
Exposure Time	(0018,1150)	Cumulative time: pulse width * number of frames
Exposure	(0018,1152)	
Exposure in μ As	(0018,1153)	
X-Ray Tube Current	(0018,1151)	From Acquisition, in mA
Filter Type	(0018,1160)	Defined Terms: “NONE”, “CU_0.1_MM”, “CU_0.2_MM”, “CU_0.3_MM”
Average Pulse Width	(0018,1154)	From Acquisition
Radiation Setting	(0018,1155)	GR or SC
Radiation Mode	(0018,115A)	PULSED
Image Area Dose Product	(0018,115E)	If dose measurement is available, in dGy cm ²
Imager Pixel Spacing	(0018,1164)	For detector images: “0.148\0.148” or “0.296\0.296” or “0.444\0.444” For I.I. images: zoomed image size/1024
Grid	(0018,1166)	“NONE”, “FOCUSED”, “UNIVERSAL”
Date of Last Calibration	(0018,1200)	
Acquisition Device Processing Description	(0018,1400)	Description of processing parameter set
Acquisition Device Processing Code	(0018,1401)	Code to identify processing parameter set
Relative X-Ray Exposure	(0018,1405)	Exposure Index (EXI)
Column Angulation	(0018,1450)	From Acquisition
Tomo Layer Height	(0018,1460)	only for tomo acquisitions
Tomo Angle	(0018,1470)	only for tomo acquisitions
Tomo Time	(0018,1480)	only for tomo acquisitions
Positioner Type	(0018,1508)	
Shutter Shape	(0018,1600)	RECTANGULAR for detector images CIRCULAR for I.I. images
Shutter Left Vertical Edge	(0018,1602)	From Acquisition / Post-processing
Shutter Right Vertical Edge	(0018,1604)	From Acquisition / Post-processing
Shutter Upper Horizontal Edge	(0018,1606)	From Acquisition / Post-processing
Shutter Lower Horizontal Edge	(0018,1608)	From Acquisition / Post-processing
Center of Circular Shutter	(0018,1610)	for I.I. images
Radius of Circular Shutter	(0018,1612)	for I.I. images
View Position	(0018,5101)	Only if information is available
Sensitivity	(0018,6000)	
Detector Conditions Nominal Flag	(0018,7000)	Set to “NO” if user was notified about possible image quality compromise, e.g. because detector

Attribute Name	Tag	Value
		temperature is out of range
Detector Temperature	(0018,7001)	the last received detector temperature is used
Detector Type	(0018,7004)	"SCINTILLATOR"
Detector Description	(0018,7006)	only for detector images Detector data: - Factory Serial Number - Factory Date Code - Configuration Version - Factory Part Number
Detector ID	(0018,700A)	Factory Serial Number
Date of Last Detector Calibration	(0018,700C)	
Time of Last Detector Calibration	(0018,700E)	
Field of View Origin	(0018,7030)	
Field of View Rotation	(0018,7032)	Enumerated Values: "0", "90", "180", "270"
Field of View Horizontal Flip	(0018,7034)	Enumerated Values: "NO", "YES"
Grid Focal Distance	(0018,704C)	"1150", "1250", "1500", "1800", "3000" only if Grid (0018,1166) = FOCUSED"
X-Ray Tube Current in μ A	(0018,8151)	
Samples per Pixel	(0028,0002)	
Photometric Interpretation	(0028,0004)	
Number of Frames	(0028,0008)	Only if multi-frame
Frame Increment Pointer	(0028,0009)	<0018,1063> only if multi-frame
Rows	(0028,0010)	
Columns	(0028,0011)	
Pixel Spacing	(0028,0030)	only if configured in service value = 0018,1164 if no SOD is present otherwise: value = (0018,1164) * SOD / SID
Bits Allocated	(0028,0100)	
Bits Stored	(0028,0101)	
High Bit	(0028,0102)	
Pixel Representation	(0028,0103)	
Pixel Intensity Relationship	(0028,1040)	LIN
Representative Frame Number	(0028,6010)	Only if multi-frame

A.5 CR Standard Extended SOP Class

“overview of supplied attributes –CR image”

Attribute Name	Tag	Value
Modality	(0008,0060)	CR
Body Part Examined	(0018,0015)	-value from OGP -Zero length if not available
KVP	(0018,0060)	From Acquisition
Device Serial Number	(0018,1000)	From Configuration
Software Version	(0018,1020)	From Configuration
Protocol Name	(0018,1030)	Organ Program Name
Distance Source to Detector	(0018,1110)	SID from Acquisition
Distance Source to Patient	(0018,1111)	- SOD (only if table object distance, image receptor table distance and SID are available) - not available for free exposures
Table Angle	(0018,1138)	From Acquisition
Table Type	(0018,113A)	"TILTING"
Field of View Shape	(0018,1147)	"RECTANGLE"
Field of View Dimension(s)	(0018, 1149)	rows\columns in mm
Exposure Time	(0018,1150)	
Exposure	(0018,1152)	
Exposure in μ As	(0018,1153)	
X-Ray Tube Current	(0018,1151)	From Acquisition, in mA
Filter Type	(0018,1160)	Defined Terms: "NONE", "CU_0.1_MM", "CU_0.2_MM", "CU_0.3_MM"
Radiation Setting	(0018,1155)	GR
Radiation Mode	(0018,115A)	PULSED
Image Area Dose Product	(0018,115E)	Only if dose measurement is available, in dGy cm ²
Imager Pixel Spacing	(0018,1164)	Depending from detector type
Grid	(0018,1166)	"NONE", "FOCUSED", "UNIVERSAL"
Acquisition Device Processing Description	(0018,1400)	Description of processing parameter set
Acquisition Device Processing Code	(0018,1401)	Code to identify processing parameter set
Relative X-Ray Exposure	(0018,1405)	Exposure Index (EXI)
Exposure Index	(0018,1411)	Clinical Exi value, (in units of 100.uGy)
Target Exposure Index	(0018,1412)	From OGP, (in units of 100.uGy)
Deviation Index	(0018,1413)	
Column Angulation	(0018,1450)	From Acquisition
Tomo Layer Height	(0018,1460)	only for tomo acquisitions
Tomo Angle	(0018,1470)	only for tomo acquisitions
Tomo Time	(0018,1480)	only for tomo acquisitions
Positioner Type	(0018,1508)	
Patient Position	(0018,5100)	not available
View Position	(0018,5101)	Only if information is available
Sensitivity	(0018,6000)	
Detector Conditions Nominal Flag	(0018,7000)	Set to "NO" if user was notified about possible image quality compromise, e.g. because detector temperature is out of range
Detector Temperature	(0018,7001)	the last received detector temperature is used
Detector Type	(0018,7004)	"SCINTILLATOR"
Detector Description	(0018,7006)	only for detector images Detector data: - Factory Serial Number - Factory Date Code - Configuration Version - Factory Part Number
Detector ID	(0018,700A)	Factory Serial Number

Attribute Name	Tag	Value
Date of Last Detector Calibration	(0018,700C)	
Time of Last Detector Calibration	(0018,700E)	
Field of View Origin	(0018,7030)	
Field of View Rotation	(0018,7032)	Enumerated Values: "0", "90", "180", "270"
Field of View Horizontal Flip	(0018,7034)	Enumerated Values: "NO", "YES"
Grid Focal Distance	(0018,704C)	"1150", "1250", "1500", "1800", "3000" only if Grid (0018,1166) = FOCUSED"
X-Ray Tube Current in μ A	(0018,8151)	
Samples per Pixel	(0028,0002)	
Photometric Interpretation	(0028,0004)	
Rows	(0028,0010)	
Columns	(0028,0011)	
Pixel Spacing	(0028,0030)	only if configured in service value = 0018,1164 if no SOD is present otherwise: value = (0018,1164) * SOD / SID
Bits Allocated	(0028,0100)	
Bits Stored	(0028,0101)	
High Bit	(0028,0102)	
Pixel Representation	(0028,0103)	
Pixel Intensity Relationship	(0028,1040)	DISP

A.6 X-Ray Radiation Dose SR SOP Class

The FLUOROSPOT Compact will create X-Ray Radiation Dose SRs implementing TID 10001 Projection Ray Radiation Dose. For every single acquisition event an entry is made into the SR.

Fluoro irradiation events are not reported in single irradiation event containers but accumulated dose values are reported in the Container "Accumulated X-Ray Dose Data"/"Fluoro Dose Area Product Total", "Fluoro Dose (RP) Total" and "Total Fluoro Time".

The scope of accumulation is "Study" or "Performed Procedure Step" if MPPS is configured.

The report is kept open (Completion Flag (0040,A491) = "PARTIAL") to support continuation of the study. Closing a study will set the Completion Flag (0040,A491) to "COMPLETED". Updating of a SR will not change the SOP Instance UID.

All patient level, study level and equipment information is taken from the acquired images of the related procedure. Attribute mapping from Modality Worklist to X-Ray Radiation Dose SR is equal to the mapping into acquired images. Please refer to A.10 FLUOROSPOT Compact Worklist Identifier for mapping for worklist information.

A.7 EXAM Protocol as Secondary Capture Image

The FLUOROSPOT Compact will create a secondary capture image, containing the “Exam Protocol” as image. The Secondary Capture Image Storage Service Class (1.2.840.10008.5.1.4.1.1.7) is used for this.

The value for Modality (0008,0060) depends on the images, acquired for this procedure step. If **only** RAD images are present, “CR” is used. If DFR images are present “RF” is used.

Additionally the following private attributes are used for documentation of accumulated dose values:

Tag	Private Owner Code	Name	VR	VM
(0017,xxD0)	SIEMENS_FLCOMPACT_VA01A_PROC	Accumulated fluorotime in sec	US	1
(0017,xxD1)	SIEMENS_FLCOMPACT_VA01A_PROC	Accumulated DAP in dGy*cm*cm	LO	1
(0017,xxD2)	SIEMENS_FLCOMPACT_VA01A_PROC	Accumulated Skin Dose in mGy	LO	1

The scope of accumulation is the Procedure Step.

A.8 SOP Common Module – Image Type Extensions

“overview of settings in tag Image Type (0008,0008)”

Type of Scene / Image	Image Type
Standard Fluoro Image (Single and Scene)	ORIGINAL\PRIMARY\SINGLE PLANE
Store Monitor of Standard Single Image	DERIVED\SECONDARY\SINGLE PLANE\STORE MONITOR
Store Monitor Average	DERIVED\SECONDARY\SINGLE PLANE\SUM
Store Monitor Peak Opacification	DERIVED\SECONDARY\SINGLE PLANE\PEAKOP
Store Monitor Last Image Hold	DERIVED\SECONDARY\SINGLE PLANE\LIH
Twinview/Quadview Image	DERIVED\SECONDARY\SINGLE PLANE\COMBI
Tomography Image	ORIGINAL\PRIMARY\TOMO
Tomography Image (Image Intensifier)	ORIGINAL\PRIMARY\SINGLE PLANE\TOMO
Peristeping Series	ORIGINAL\PRIMARY\SINGLE PLANE\PERI
Scan Mode Image	ORIGINAL\PRIMARY\SINGLE PLANE\SCAN
Stored Fluoroscopy	ORIGINAL\PRIMARY\SINGLE PLANE\LOOP
Radiography Image	ORIGINAL\PRIMARY\RAD
Tilting Ortho Mode Image	ORIGINAL\PRIMARY\TILTING
Exam Protocol as Secondary Capture	DERIVED\SECONDARY\SINGLE PLANE\EXAM PROTOCOL
Composed Image	DERIVED\SECONDARY\SPINE\VIEWER VB15A DERIVED\SECONDARY\LLD_ORTHO_ONE_LEG\Viewer VB15A DERIVED\SECONDARY\LLD_ORTHO\Viewer VB15A
Videonmanager Image	ORIGINAL\PRIMARY\SINGLE PLANE\CAP

A.9 Private Data

A.9.1 General Private Data

The following table describes private data that may be used for all IODs.

“overview of private data in all images”

Tag	Private Owner Code	Name	VR	VM
(0017,xx0A)	SIEMENS_FLCOMPACT_VA01A_PROC	Internal Data	SS	1
(0017,xx0B)	SIEMENS_FLCOMPACT_VA01A_PROC	Internal Data	SS	1
(0017,xx0C)	SIEMENS_FLCOMPACT_VA01A_PROC	Internal Data	SS	1
(0017,xx0D)	SIEMENS_FLCOMPACT_VA01A_PROC	Internal Data	FL	1
(0017,xx0E)	SIEMENS_FLCOMPACT_VA01A_PROC	Internal Data	LO	1
(0017,xx0F)	SIEMENS_FLCOMPACT_VA01A_PROC	Internal Data	LO	1
(0017,xx10)	SIEMENS_FLCOMPACT_VA01A_PROC	Internal Data	SS	1
(0017,xx11)	SIEMENS_FLCOMPACT_VA01A_PROC	Internal Data	SS	1
(0017,xx14)	SIEMENS_FLCOMPACT_VA01A_PROC	Internal Data	US	1
(0017,xx16)	SIEMENS_FLCOMPACT_VA01A_PROC	Internal Data	US	1
(0017,xx17)	SIEMENS_FLCOMPACT_VA01A_PROC	Internal Data	US	1
(0017,xx18)	SIEMENS_FLCOMPACT_VA01A_PROC	Internal Data	US	1
(0017,xx19)	SIEMENS_FLCOMPACT_VA01A_PROC	Internal Data	US	1
(0017,xx1A)	SIEMENS_FLCOMPACT_VA01A_PROC	Internal Data	US	1
(0017,xx1B)	SIEMENS_FLCOMPACT_VA01A_PROC	Internal Data	US	1
(0017,xx1C)	SIEMENS_FLCOMPACT_VA01A_PROC	Internal Data	US	1
(0017,xx1E)	SIEMENS_FLCOMPACT_VA01A_PROC	Internal Data	US	1
(0017,xx1F)	SIEMENS_FLCOMPACT_VA01A_PROC	Internal Data	SS	1
(0017,xx20)	SIEMENS_FLCOMPACT_VA01A_PROC	Internal Data	SS	1
(0017,xx21)	SIEMENS_FLCOMPACT_VA01A_PROC	Internal Data	US	1
(0017,xx22)	SIEMENS_FLCOMPACT_VA01A_PROC	Internal Data	US	1
(0017,xx23)	SIEMENS_FLCOMPACT_VA01A_PROC	Internal Data	US	1

Tag	Private Owner Code	Name	VR	VM
(0017,xx24)	SIEMENS_FLCOMPACT_VA01A_PROC	Internal Data	US	1
(0017,xx25)	SIEMENS_FLCOMPACT_VA01A_PROC	Internal Data	US	1
(0017,xx26)	SIEMENS_FLCOMPACT_VA01A_PROC	Internal Data	US	1
(0017,xx27)	SIEMENS_FLCOMPACT_VA01A_PROC	Internal Data	US	1
(0017,xx28)	SIEMENS_FLCOMPACT_VA01A_PROC	Internal Data	FL	1
(0017,xx29)	SIEMENS_FLCOMPACT_VA01A_PROC	Internal Data	FL	1
(0017,xx48)	SIEMENS_FLCOMPACT_VA01A_PROC	Internal Data	SS	1
(0017,xx49)	SIEMENS_FLCOMPACT_VA01A_PROC	Internal Data	SS	1
(0017,xx4D)	SIEMENS_FLCOMPACT_VA01A_PROC	Internal Data	SS	1
(0017,xx4E)	SIEMENS_FLCOMPACT_VA01A_PROC	Internal Data	LO	1
(0017,xx4F)	SIEMENS_FLCOMPACT_VA01A_PROC	Internal Data	LO	1
(0017,xx50)	SIEMENS_FLCOMPACT_VA01A_PROC	Internal Data	SS	1
(0017,xx52)	SIEMENS_FLCOMPACT_VA01A_PROC	Internal Data	SS	1
(0017,xx53)	SIEMENS_FLCOMPACT_VA01A_PROC	Internal Data	SS	1
(0017,xx54)	SIEMENS_FLCOMPACT_VA01A_PROC	Internal Data	SS	1
(0017,xx55)	SIEMENS_FLCOMPACT_VA01A_PROC	Internal Data	SS	1
(0017,xx5C)	SIEMENS_FLCOMPACT_VA01A_PROC	Internal Data	OW	1
(0017,xx64)	SIEMENS_FLCOMPACT_VA01A_PROC	Internal Data	US	1
(0017,xx66)	SIEMENS_FLCOMPACT_VA01A_PROC	Internal Data	US	1
(0017,xx67)	SIEMENS_FLCOMPACT_VA01A_PROC	Internal Data	US	1
(0017,xx68)	SIEMENS_FLCOMPACT_VA01A_PROC	Internal Data	US	1
(0017,xx85)	SIEMENS_FLCOMPACT_VA01A_PROC	Internal Data	US	1
(0017,xx86)	SIEMENS_FLCOMPACT_VA01A_PROC	Internal Data	US	1
(0017,xx87)	SIEMENS_FLCOMPACT_VA01A_PROC	Internal Data	US	1
(0017,xx88)	SIEMENS_FLCOMPACT_VA01A_PROC	Internal Data	US	1
(0017,xx89)	SIEMENS_FLCOMPACT_VA01A_PROC	Internal Data	US	1
(0017,xx8A)	SIEMENS_FLCOMPACT_VA01A_PROC	Internal Data	US	1
(0017,xx8B)	SIEMENS_FLCOMPACT_VA01A_PROC	Internal Data	US	1
(0017,xx8C)	SIEMENS_FLCOMPACT_VA01A_PROC	Internal Data	FL	1
(0017,xx8D)	SIEMENS_FLCOMPACT_VA01A_PROC	Internal Data	FL	1
(0017,xx8E)	SIEMENS_FLCOMPACT_VA01A_PROC	Internal Data	US	1
(0017,xx8F)	SIEMENS_FLCOMPACT_VA01A_PROC	Internal Data	US	1
(0017,xx90)	SIEMENS_FLCOMPACT_VA01A_PROC	Internal Data	US	1
(0017,xx91)	SIEMENS_FLCOMPACT_VA01A_PROC	Internal Data	US	1
(0017,xx92)	SIEMENS_FLCOMPACT_VA01A_PROC	Internal Data	US	1
(0017,xxA0)	SIEMENS_FLCOMPACT_VA01A_PROC	Internal Data	US	1
(0017,xxA1)	SIEMENS_FLCOMPACT_VA01A_PROC	Internal Data	US	1
(0017,xxA2)	SIEMENS_FLCOMPACT_VA01A_PROC	Internal Data	LO	1
(0017,xxAA)	SIEMENS_FLCOMPACT_VA01A_PROC	Internal Data	US	1
(0017,xxAB)	SIEMENS_FLCOMPACT_VA01A_PROC	Internal Data	US	1
(0017,xxB0)	SIEMENS_FLCOMPACT_VA01A_PROC	Internal Data	DS	1
(0017,xxBF)	SIEMENS_FLCOMPACT_VA01A_PROC	name of the performed OGP	LO	1
(0017,xxC0)	SIEMENS_FLCOMPACT_VA01A_PROC	name of the performed Exam	LO	1
(0017,xxC1)	SIEMENS_FLCOMPACT_VA01A_PROC	Internal Data	US	1
(0017,xxC2)	SIEMENS_FLCOMPACT_VA01A_PROC	Internal Data	US	1
(0017,xxC3)	SIEMENS_FLCOMPACT_VA01A_PROC	Stored marking number	US	1
(0017,xxC4)	SIEMENS_FLCOMPACT_VA01A_PROC	"Name for RIS" of the performed exam	LO	1

Tag	Private Owner Code	Name	VR	VM
(0019,xx06)	Thorax/Multix FD Lab Settings	Table Object Distance	FD	1
(0019,xx07)	Thorax/Multix FD Lab Settings	Table Detector Distance	FD	1
(0019,xx08)	Thorax/Multix FD Lab Settings	Ortho Step Distance	US	1-n

Tag	Private Owner Code	Name	VR	VM
(0019,xx09)	Thorax/Multix FD Lab Settings	Asymmetric Collimation	LO	1
(0021,xx08)	Thorax/Multix FD Post Processing	Auto Window Flag	US	1
(0021,xx09)	Thorax/Multix FD Post Processing	Auto Window Center	SL	1
(0021,xx0A)	Thorax/Multix FD Post Processing	Auto Window Width	SL	1
(0021,xx0B)	Thorax/Multix FD Post Processing	Filter ID	SS	1
(0021,xx13)	Thorax/Multix FD Post Processing	Internal Value	US	1
(0021,xx14)	Thorax/Multix FD Post Processing	Anatomic Correct View	US	1
(0021,xx15)	Thorax/Multix FD Post Processing	Auto Window Shift	SS	1
(0021,xx16)	Thorax/Multix FD Post Processing	Auto Window Expansion	DS	1
(0021,xx17)	Thorax/Multix FD Post Processing	System Type	LO	1
(0021,xx18)	Thorax/Multix FD Post Processing	Detector Type	LO	1
(0021,xx30)	Thorax/Multix FD Post Processing	Anatomic Sort Number	SH	1
(0021,xx31)	Thorax/Multix FD Post Processing	Acquisition Sort Number	SH	1
(0025,xx00)	Siemens: Thorax/Multix FD Raw Image Settings	Raw Image Amplification	SS	1
(0025,xx0C)	Siemens: Thorax/Multix FD Raw Image Settings	Harmonization Kernel	SS	1
(0025,xx0D)	Siemens: Thorax/Multix FD Raw Image Settings	Harmonization Gain	FL	1
(0025,xx0E)	Siemens: Thorax/Multix FD Raw Image Settings	Edge Enhancement Kernel	SS	1
(0025,xx0F)	Siemens: Thorax/Multix FD Raw Image Settings	Edge Enhancement Gain	FL	1
(0025,xx10)	Siemens: Thorax/Multix FD Raw Image Settings	Internal Value	LT	1
(0025,xx18)	Siemens: Thorax/Multix FD Raw Image Settings	Auto Gain	US	1
(0025,xx19)	Siemens: Thorax/Multix FD Raw Image Settings	Ortho Subsampling	US	1
(0025,xx1A)	Siemens: Thorax/Multix FD Raw Image Settings	Image Crop Upper Left	US	2
(0025,xx1B)	Siemens: Thorax/Multix FD Raw Image Settings	Image Crop Upper Right	US	2
(0025,xx1C)	Siemens: Thorax/Multix FD Raw Image Settings	Image Crop Lower Left	US	2
(0025,xx1D)	Siemens: Thorax/Multix FD Raw Image Settings	Image Crop Lower Right	US	2
(0025,xx30)	Siemens: Thorax/Multix FD Raw Image Settings	Manual Cropping	US	1
(0025,xx31)	Siemens: Thorax/Multix FD Raw Image Settings	Gamma LUT Parameter 1	SS	1
(0025,xx32)	Siemens: Thorax/Multix FD Raw Image Settings	Gamma LUT Parameter 2	DS	1
(0025,xx33)	Siemens: Thorax/Multix FD Raw Image Settings	Gamma LUT Parameter 3	SS	1
(0025,xx34)	Siemens: Thorax/Multix FD Raw Image Settings	Gamma LUT Parameter 4	SS	1
(0025,xx35)	Siemens: Thorax/Multix FD Raw Image Settings	Gamma LUT Name	LO	1
(0025,xx36)	Siemens: Thorax/Multix FD Raw Image Settings	Physical Exi	DS	1
(0025,xx37)	Siemens: Thorax/Multix FD Raw Image Settings	Clinical Exi	DS	1

A.10 FLUOROSPOT Compact Worklist Identifier

Module Name Attribute Name	Matching Key Type	Return Key Type	Tag	M	R	Q	I O D	DICOM Part 3 Tables
SOP Common								C.12- 1
Specific Character Set	O	1C	0008,0005		x			
Scheduled Procedure Step								C.4-10
Scheduled Procedure Step Sequence	R	1	0040,0100		x			
> Scheduled Station AET	R	1	0040,0001	S				
> Scheduled Procedure Step Start Date	R	1	0040,0002	S				
> Scheduled Procedure Step Start Time	R	1	0040,0003	S				
> Modality	R	1	0008,0060	S				
> Scheduled Performing Physician's Name	R	2	0040,0006		x	x	x ¹	
> Scheduled Procedure Step Description	O	1C	0040,0007		x		x	
> Scheduled Protocol Code Sequence	O	1C	0040,0008		x		x	
>> Code Value	O	1C	0008,0100		x		x	
>> Coding Scheme Designator	O	1C	0008,0102		x		x	
>> Coding Scheme Version	O	3	0008,0103		x		x	
>> Code Meaning	O	3	0008,0104		x		x	
> Scheduled Procedure Step Location	O	2	0040,0011		x			
> Pre-Medication	O	2	0040,0012		x			
> Scheduled Procedure Step ID	O	1	0040,0009		x		x	
> Scheduled Procedure Step Status	O	3	0040,0020		x			
> Requested Contrast Agent	O	2C	0032,1070		x			
Requested Procedure								C.4-11
Requested Procedure ID	O	1	0040,1001		x	x	x ²	
Requested Procedure Description	O	1C	0032,1060		x		x ³	
Requested Procedure Code Sequence	O	1C	0032,1064		x		x ⁴	
> Code Value	O	1C	0008,0100		x		x ⁴	
> Coding Scheme Designator	O	1C	0008,0102		x		x ⁴	
> Coding Scheme Version	O	3	0008,0103		x		x ⁴	
> Code Meaning	O	3	0008,0104		x		x ⁴	
Study Instance UID	O	1	0020,000D		x		x	
Referenced Study Sequence	O	2	0008,1110		x		x	
> Referenced SOP Class UID	O	1C	0008,1150		x		x	
> Referenced SOP Instance UID	O	1C	0008,1155		x		x	
Requested Procedure Priority	O	2	0040,1003		x			
Names of Intended Recipients of Results	O	3	0040,1010		x			
Requested Procedure Comments	O	3	0040,1400		x			
Imaging Service Request								C.4-12
Accession Number	O	2	0008,0050		x	x	x	
Requesting Physician	O	2	0032,1032		x			
Referring Physician's Name	O	2	0008,0090		x	x	x	
Requesting Service	O	3	0032,1033		x			
Imaging Service Request Comments	O	3	0040,2400		x			
Visit Identification								C.3-2
Institution Name	O	3	0008,0080		x			
Admission ID	O	2	0038,0010		x			
Visit Status								C.3-3
Current Patient Location	O	2	0038,0300		x	x		
Visit Admission								C.3-4
Admitting Diagnoses Description	O	3	0008,1080		x		x	
Visit Relationship								C.3-1
Referenced Patient Sequence	O	3	0008,1120		x		x	
> Referenced SOP Class UID	O	1C	0008,1150		x		x	
> Referenced SOP Instance UID	O	1C	0008,1155		x		x	
Patient Identification								C.2-2
Patient Name	R	1	0010,0010		x	x	x	
Patient ID	R	1	0010,0020		x	x	x	

Module Name Attribute Name	Matching Key Type	Return Key Type	Tag	M	R	Q	I O D	DICOM Part 3 Tables
Other Patient Ids	O	3	0010,1000		x		x	
Other Patient Names	O	3	0010,1001		x		x	
Patient Demographic								C.2-3
Patient's Birth Date	O	2	0010,0030		x		x ⁵	
Patient's Sex	O	2	0010,0040		x		x	
Patient's Weight	O	2	0010,1030		x		x	
Patient's Size	O	3	0010,1020		x		x	
Patient's Address	O	3	0010,1040		x			
Military Rank	O	3	0010,1080		x			
Ethnic Group	O	3	0010,2160		x		x	
Patient Comments	O	3	0010,4000		x		x	
Confidentiality Constraints on Patient Data	O	3	0040,3001		X			
Patient Medical								C.2-4
Patient State	O	2	0038,0500		x			
Patient Weight	O	3	0010,1030		x			
Pregnancy Status	O	2	0010,21C0		x			
Medical Alerts	O	2	0010,2000		x			
Contrast Allergies	O	2	0010,2110		x			
Special Needs	O	2	0038,0050		x			
Smoking Status	O	3	0010,21A0		x			
Additional Patient History	O	3	0010,21B0		x		x	
Last Menstrual Date	O	3	0010,21D0		x			

The table should be read as follows:

- Attribute Name:** Attributes supported to build a FLUOROSPOT Compact Worklist Request Identifier.
- Matching Key Type:** Requested [R] or optional [O] Matching key. The FLUOROSPOT Compact assumes that the Modality Worklist SCP supports Matching Keys as defined in DICOM PS 3.4 K 2.2, i.e. that the SCP is able to at least perform Single Value, Wildcard and Date Range matching.
- Return Key Type:** Mandatory, conditional and optional Return key.
- Tag:** Appropriate DICOM tag for this attribute.
- M:** Matching keys for Worklist Update. A "S" will indicate that FLUOROSPOT Compact will supply an attribute value for Single Value Matching.
It can be configured that the attribute is used as Return Key only
- R:** Return keys. A "x" will indicate that FLUOROSPOT Compact will supply this attribute as Return Key with zero length for Universal Matching.
- Q:** Interactive Query Key. A "x" will indicate that FLUOROSPOT Compact will supply this attribute as matching key, if entered in the Query Patient Worklist dialog. The other keys will then be Return Keys only.
- IOD:** An "x" indicates that this Worklist attribute is included into all Object Instances created during performance of the related Procedure Step.

The default Query Configuration is set to "Modality" and "Date". Optionally, matching for the own "AE Title" and "Date" is configurable. For "Date" one of the following settings could be configured: "Today", "Yesterday – Today", "Today +/- 12 hours", "Today +/- 24 hours", and "Use no Date".

In Patient based worklist update, the usage of date and time can be deactivated! The Scheduled AE Title is used as Return Key only.

x¹ : "Scheduled Performing Physician's Name (0040,0006)" is not directly included in the header. However, its value is stored in the header as "Performing Physician's Name (0008,1050)". It can be modified by user during Patient Registration.

x² : Requested Procedure ID (0040,1001) is directly included in the header. Additionally , its value is stored in the header as Study ID (0020,0010). Study ID can be modified by the user during Patient Registration.

x³ : Requested Procedure Description (0032,1060) is not directly included in the header. However, its value is stored in the header as "Study Description (0008,1030)". It can be modified by user during Patient Registration.

x⁴ : Requested Procedure Code Sequence (0032,1064) is not directly included in the header. However, its value is stored in the header as "Procedure Code Sequence (0008,1032)". It is not sent, when the scheduled protocol codes differ from the performed protocol codes.

x⁵ : If a date of birth (0010,0030) with zero_length value is received via worklist, the date of birth will internally set to 1850/01/01.
The value 1850/01/01 for the date of birth is not used in a DICOM header (DICOM Send, MPPS, CD/DVD Export), but again replaced by zero_length.

A.11 Modality Performed Procedure Step Identifiers

Attribute Name	Tag	N-CREATE no value	N-CREATE with value	N-SET Final
Specific Character Set	(0008,0005)		value depends on regional settings	./.
Modality	(0008,0060)		"CR", "RF"	./.
Procedure Code Sequence	(0008,1032)	- If not received via worklist - for unscheduled case	If received via worklist	./.
> Code Value	(0008,0100)		From Modality Worklist (0032,1064)	
> Coding Scheme Designator	(0008,0102)		From Modality Worklist (0032,1064)	
> Coding Scheme Version	(0008,0103)		From Modality Worklist (0032,1064)	
> Code Meaning	(0008,0104)		From Modality Worklist (0032,1064)	
Referenced Patient Sequence	(0008,1120)	Y		./.
Patient's Name	(0010,0010)		From Modality Worklist or user input (all 5 components)	./.
Patient ID	(0010,0020)		From Modality Worklist or user input	./.
Patient's Birth Date	(0010,0030)		From Modality Worklist or user input	./.
Patient's Sex	(0010,0040)		From Modality Worklist or user input	./.
Distance Source to Detector (SID)	(0018,1110)	Y		minimum value
Image Area Dose Product	(0018,115E)	Y		includes fluoro and cassette images
Study ID	(0020,0010)		From Modality Worklist (0040,1001) or user input	./.
Performed Station AE Title	(0040,0241)		AE Title of MPPS SCU	./.
Performed Station Name	(0040,0242)		Hostname	./.
Performed Location	(0040,0243)	Y		./.
Performed Procedure Step Start Date	(0040,0244)		Y	./.
Performed Procedure Step Start Time	(0040,0245)		Y	./.
Performed Procedure Step End Date	(0040,0250)	Y		./ (if IN PROGRESS) Actual end date (ELSE)
Performed Procedure Step End Time	(0040,0251)	Y		./ (if IN PROGRESS) Actual end time (ELSE)
Performed Procedure Step Status	(0040,0252)		IN PROGRESS	IN PROGRESS DISCONTINUED COMPLETED
Performed Procedure Step ID	(0040,0253)		System generated	./.
Performed Procedure Step Description	(0040,0254)		From Modality Worklist (0040,0007)	(0040,0007) or user input
Performed Procedure Type Description	(0040,0255)	Y		zero Length
Performed Protocol Code Sequence ³	(0040,0260)			./.
> Code Value	(0008,0100)		From performed Exam	From performed Exam
> Coding Scheme Designator	(0008,0102)		From performed Exam	From performed Exam
> Coding Scheme Version	(0008,0103)		From performed Exam	From performed Exam

³ items only present if system is configured to use protocol codes, otherwise zero length

Attribute Name	Tag	N-CREATE no value	N-CREATE with value	N-SET Final
> Code Meaning	(0008,0104)		From performed Exam	From performed Exam
Scheduled Step Attributes Sequence	(0040,0270)		If 1 st dose applied results in an Instance	./.
> Accession Number	(0008,0050)		From Modality Worklist	./.
> Referenced Study Sequence	(0008,1110)			./.
>> Referenced SOP Class UID	(0008,1150)		From Modality Worklist	./.
>> Referenced SOP Instance UID	(0008,1155)		From Modality Worklist	./.
> Study Instance UID	(0020,000D)		From Modality Worklist	./.
> Requested Procedure Description	(0032,1060)		From Modality Worklist	./.
> Scheduled Procedure Step Description	(0040,0007)		From Modality Worklist	./.
> Scheduled Protocol Code Sequence	(0040,0008)			./.
>> Code Value	(0008,0100)		From Modality Worklist (0040,0008)	./.
>> Coding Scheme Designator	(0008,0102)		From Modality Worklist (0040,0008)	./.
>> Coding Scheme Version	(0008,0103)		From Modality Worklist (0040,0008)	./.
>> Code Meaning	(0008,0104)		From Modality Worklist (0040,0008)	./.
> Scheduled Procedure Step ID	(0040,0009)		From Modality Worklist	./.
> Requested Procedure ID	(0040,1001)		From Modality Worklist	./.
Performed Procedure Step Discontinuation Reason Code Sequence	(0040,0281)	Y		only if (0040,0252) = "DISCONTINUED"
> Code Value				See Context ID 9300 DICOM 3.16
> Coding Scheme Designator	(0008,0102)			DCM
> Code Meaning	(0008,0104)			See Context ID 9300
Total Time of Fluoroscopy	(0040,0300)	Y		Total time
Total Number of Exposures	(0040,0301)	Y		Number of exposures
Distance Source to Entrance	(0040,0306)	Y		Minimum value
Exposure Dose Sequence	(0040,030E)	Y		Zero or more items
> KVP	(0018,0060)			
> X-Ray Tube Current in μ A	(0018,8151)			
> Exposure Time	(0018,1150)			
> Filter Type	(0018,1160)			
Comments on Radiation Dose	(0018,0310)	Y		Formatted table of dose information for all acquisition events format: <OGP dGy*cm^2 kV mAs Filter Physical EXI>\r\n
Billing Procedure Sequence	(0040,0320)	Y		Zero or more items
Film Consumption Sequence	(0040,0321)	Y		Zero or more items
> Film Size ID	(2010,0050)			Y if Seq. present
> Number of Films	(2100,0170)			Y if Seq. present
Performed Series Sequence	(0040,0340)	Y		One or more items
> Retrieve AE Title	(0008,0054)			AE Title of archive
> Series Description	(0008,103E)	--		Organ Program Name
> Performing Physician's Name	(0008,1050)	--		from Modality Worklist (0040,0006) or user input

Attribute Name	Tag	N-CREATE no value	N-CREATE with value	N-SET Final
> Operator's Name	(0008,1070)	--		user input
> Referenced Image Sequence	(0008,1140)	--		One or more items
>> Referenced SOP Class UID	(0008,1150)	--		System dependent
>> Referenced SOP Instance UID	(0008,1155)	--		Y
> Protocol Name	(0018,1030)	--		Organ Program
> Series Instance UID	(0020,000E)	--		Y
> Referenced Non-Image Composite SOP Instance Sequence	(0040,0220)			Zero length
Entrance Dose in mGy	(0040,8302)	Y		Accumulated value, includes fluoro and cassette images

A.12 Grayscale Image Consistency

The used monitors come with a DICOM Grayscale Standard Display Function (GSDf) compliant factory pre-setting. A typical working environment setup is assumed for ambient light.